

**DAWSONS-TECH<sup>®</sup>**

OVER 35 YEARS OF EXPERIENCE



**CATALOGUE NO.  
PPA-21**

**INSTRUMENTATION / CNG  
PRECISION PIPE FITTINGS &  
TUBE ADAPTERS**

[www.dawsonstech.com](http://www.dawsonstech.com)

**THE COMPANY :**

**DAWSONS-TECH®** is an ISO 9001:2015 certified manufacturing company offers wide range of **Consistent, Reliable and Superior Quality** High Pressure Instrumentation / CNG / Hydrogen Products used in Vehicles, Fueling Equipments like CNG Cascades, CNG Dispensers, Booster Compressors, Online Compressors, Decompression Skid, LCV Filling Post, Meter Regulation Skids, Pressure Regulation Skids, etc.



dedicated team of employees in place. This facilitate us to design and manufacture our product range under stringent quality checks and measurements that ensures **"A TOTAL CUSTOMER SATISFACTIONS"**.

**QUALITY :**

**DAWSONS-TECH®** pursues not only performance of its products but also ensures **"TOTAL QUALITY CONTROL MANAGEMENT SYSTEMS IN ACCORDANCE WITH ISO 9001:2015"** which is achieved by alerting and educating each and every employee, the importance of quality and by implementing the quality control procedures at every stage of production to final inspection from incoming raw material to finish products.

**MANUFACTURING :**

**DAWSONS-TECH®** established its comprehensive state of art manufacturing and testing facility installing various CNC Turning Centre and CNC Turnmill Centre, Vertical Machining Centre, etc. with the highly motivated and

 <b>OUR CAPABILITIES</b>	 <b>CERTIFICATIONS</b>	 <b>BENEFITS</b>
<ul style="list-style-type: none"> <li>• Over 35 Years of Experience</li> <li>• Excellent Technical Knowledge</li> <li>• Latest Design Equipment's &amp; Software</li> <li>• Modern Manufacturing Facilities</li> <li>• Highly Motivated Team of Employees</li> <li>• Excellent Inspection Facilities</li> <li>• Product Performance Testing Facilities</li> </ul>	<ul style="list-style-type: none"> <li>• ISO 9001-2015</li> <li>• ISO 14001-2015</li> <li>• ISO 45001-2018</li> <li>• PED 2014/68/EU</li> <li>• ASTM F1387-19</li> <li>• MSS SP-99-2016a</li> <li>• Helium Leak Test</li> <li>• Hydro Static Proof Test</li> <li>• Pneumatic Proof Test</li> </ul>	<ul style="list-style-type: none"> <li>• High Quality</li> <li>• Proven Design for Leak Free Connections</li> <li>• Effective Operations</li> <li>• High Efficiency</li> <li>• Prompt Reply</li> <li>• Maximum Flexibility</li> <li>• Maximum Safety in Operation</li> <li>• Substantial Cost Saving</li> </ul>









**RESEARCH & DEVELOPMENT :**

With our extensive experience, expertise and continues Research & Development with incorporation of advanced technology and high-tech cutting-edge machineries, **DAWSONS-TECH®** is committed to constant upgradation and expand its product range to meet the requirements of its customer to their entire satisfaction at every time.

**CUSTOMER SATISFACTION :**

We strive to achieve total customer satisfaction and continuously work to set higher goals to provide the reliable quality, timely delivery of our products and prompt services in the best interest of our customers with **Very Competitive Price**.

**OUR MISSION**

 <b>RESPONSIBILITY</b>	 <b>RELIABILITY</b>	 <b>ENVIRONMENTAL AWARENESS</b>	 <b>TECHNICAL EXPERTISE</b>	 <b>INNOVATIVE TECHNOLOGY</b>	 <b>DEVELOPMENT</b>	 <b>CUTTING EDGE SOLUTIONS</b>	 <b>TOTAL CUSTOMER SATISFACTION</b>
---	---	---	---	---	--	--	---

## General Information :

**DAWSONS-TECH** Precision Threaded / Welded Pipe Fittings & Adaptors are generally used for small Pipe Lines. Socket Welded Joint Construction is a good choice wherever the benefit of high leakage integrity and structured strength are important.

### Features / Benefits :

- Threaded Pipe Fittings are available with NPT, BSPT & SAE Thread End Connections.
- Welded Pipe Fittings are available with Socket & Butt Weld End Connections.
- Working Pressure calculated in accordance with Power Piping Code ANSI B31.1 and Refiner Piping Code ANSI B31.3.
- Straight Fittings are manufactured from Bar Stock and Shape Fittings are manufactured from close Grain Forgings.
- Available in Material SS316.



Straight Fittings are manufactured from high quality bar stock for strength.

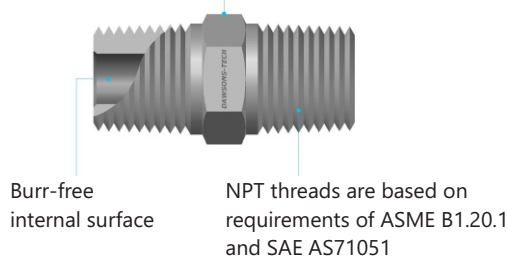

Shaped Fittings are manufactured from forgings

Marking indicates manufacturer and material of construction

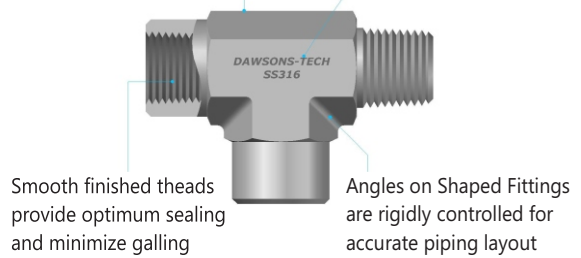

Male / Female Taper Pipe Threads are manufactured to maximum tolerances, ensures to have maximum thread engagement, robust, safe & secure connection.

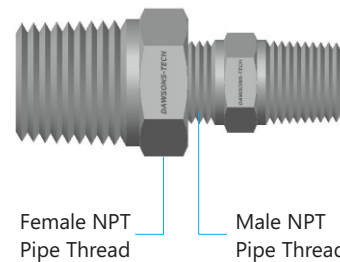

Heavy wall thickness and strength of material assures long life in desired service application

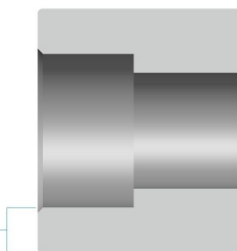

Precise machining of all surfaces assures excellent sealing contact

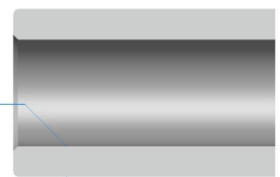

Slight taper in the Socket tube base ensure perfect assembly & alignment

Precise machining of socket assures proper tube fit

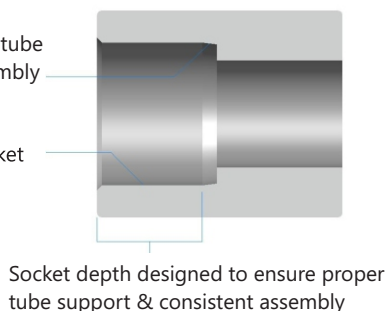

37.5° chamfer for proper weld Fillet

Precise Machining of outside Diameter matches exact pipe size

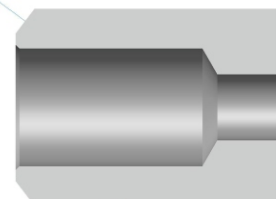

## General Information :

### Product Range & Operating Parameters :

**Pressure Rating** : UPTO 10,000 PSIG (689 Bar) depending on size at CWP.  
**Temperature Rating** : UPTO 426°C.  
**End Connections - Fractional** : 1/8" to 1" Pipe Thread / Pipe / Tube End.

### Applications :

- Instrumentations
- General Services, etc.

## Pipe Thread Information :

**DAWSONS-TECH** Pipe Fittings are available with NPT (National Pipe Thread), BSP / ISO (British Standard Pipe / International Standards Organization) and SAE/MS Straight Threads.

### Tapered Threads :

Specification	Type	Part No. or Suffix Designation	Sealing Method
NPT ANSI B1.20.1	M / F	N	Seal is on the Thread. Thread Sealant is required.
ISO 7/1	M/F	RT	Seal is on the Thread. Thread Sealant is required.
BS 21	M/F		
JIS B0203	M/F		
DIN 2999	Male		

### Parallel Threads :

Specification	Type	Part No. or Suffix Designation	Sealing Method
ISO 228 / 1+2 BS 2779 JIS B0202	Male	RP	Metal To Metal sealing to DIN 3852, Form B.
ISO 228 / 1+2 BS 2779 JIS B0202	Male	RS	Utilizes a sealing washer to provide sealing. Reference DIN 3852, Form B.
ISO 228 / 1+2 BS 27879 JIS B0202	Female	RG	Sealing Form meets DIN 3852, Form Y.
BS2779 ISO 228 / 1+2 with Elastic Sealing	Male	ED	Sealing Form meets DIN 3852, Part 2, Form E.
SAE J514	Male	SAE	Sealing with 'O' Ring

**PRECISION THREADED PIPE FITTINGS**

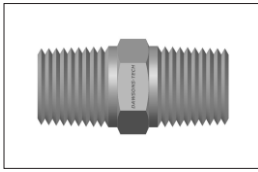

Hex Nipple  
(NPT & BSPT)  
**Page No. 07**

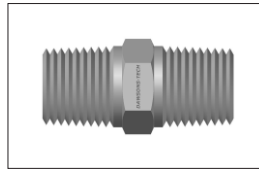

Hex Nipple  
(NPT to BSPT)  
**Page No. 07**

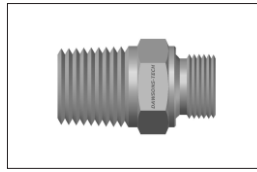

Hex Nipple  
(NPT to BSP)  
**Page No. 08**

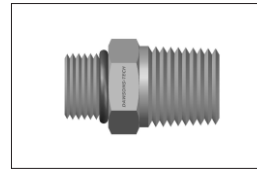

Hex Nipple  
(SAE/MS to NPT)  
**Page No. 08**

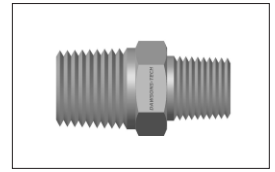

Hex Reducing Nipple  
(NPT & BSPT)  
**Page No. 09**

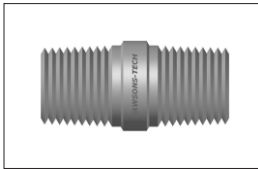

Close Nipple  
(NPT)  
**Page No. 09**

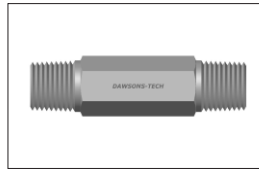

Hex Long Nipple  
(NPT)  
**Page No. 10**

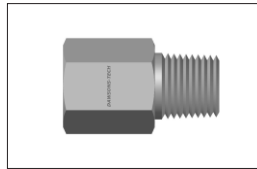

Adapter  
(NPT & BSPT)  
**Page No. 10 & 11**

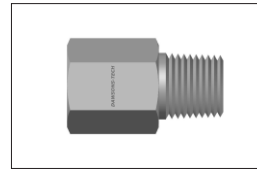

Adapter  
(NPT to BSPT)  
**Page No. 11**

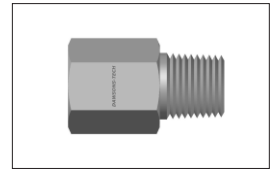

Adapter  
(NPT to BSPT) & (BSPT to NPT)  
**Page No. 11**



Adapter  
(NPT to BSP)  
**Page No. 12**

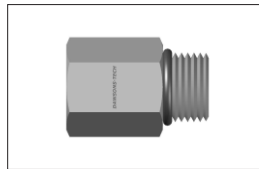

Adapter  
(NPT to SAE/MS)  
**Page No. 12**

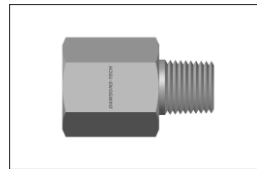

Reducing Adapter  
(NPT & BSPT)  
**Page No. 13**

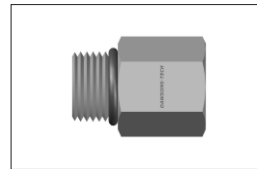

Reducing Adapter  
(SAE/MS)  
**Page No. 13**

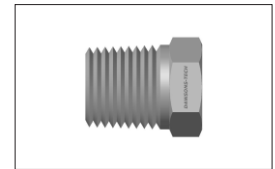

Reducing Bushing  
(NPT & BSPT)  
**Page No. 14**

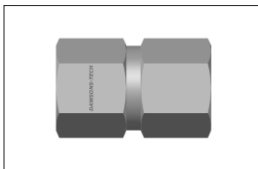

Hex Coupling  
(NPT & BSPT)  
**Page No. 14 & 15**

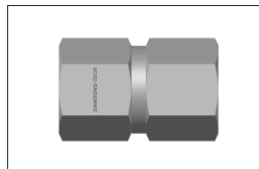

Hex Reducing Coupling  
(NPT & BSPT)  
**Page No. 15**

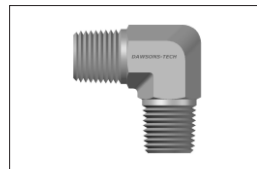

Male Elbow  
(NPT)  
**Page No. 16**

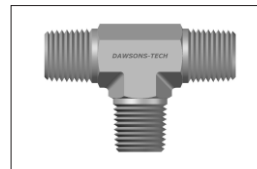

Male Tee  
(NPT)  
**Page No. 16**



Female Elbow  
(NPT & BSPT)  
**Page No. 16 & 17**

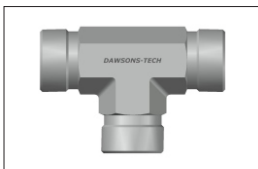

Female Tee  
(NPT & BSPT)  
**Page No. 17**

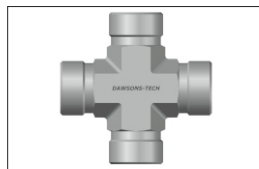

Female Cross  
(NPT)  
**Page No. 18**

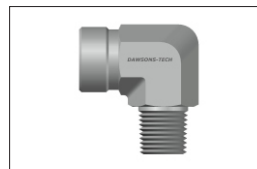

Street Elbow  
(NPT)  
**Page No. 18**

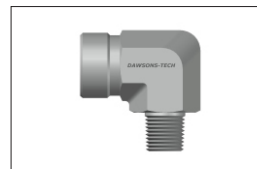

Reducing Street Elbow  
(NPT)  
**Page No. 18**

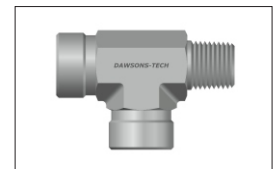

Street Tee  
(NPT)  
**Page No. 19**

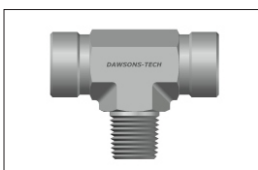

Branch Tee  
(NPT)  
**Page No. 19**

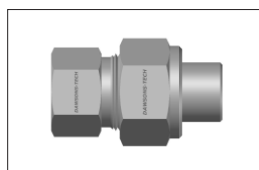

Union Ball Joint  
(NPT)  
**Page No. 19**

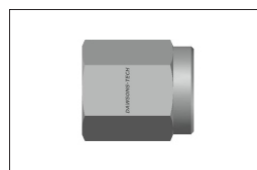

Pipe Cap  
(NPT)  
**Page No. 20**

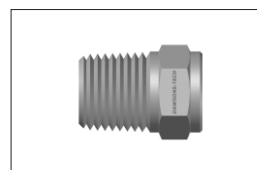

Pipe Plug  
(NPT)  
**Page No. 20**

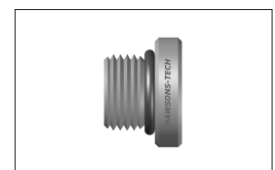

Hollow Hex Plug  
(SAE/MS)  
**Page No. 20**

**PRECISION THREADED PIPE FITTINGS**

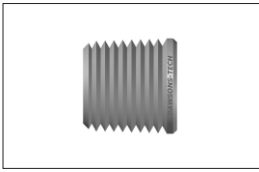

Hollow Hex Plug  
(NPT & BSPT)  
**Page No . 21**

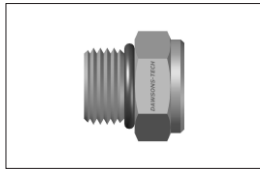

Hex Head Plug  
(SAE/MS)  
**Page No. 21**

**SOCKET / BUTT WELD PIPE FITTINGS**

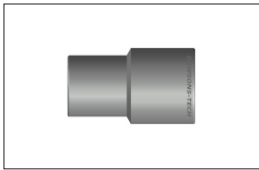

Reducing Adapter  
Tube Butt Weld to Tube Socket Weld  
**Page No. 22**

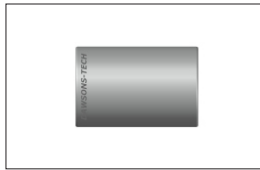

Union  
Tube Socket Weld  
**Page No. 22**



Union Elbow  
Tube Socket Weld  
**Page No. 22**

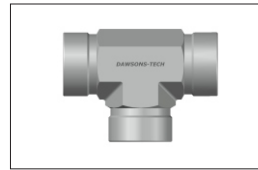

Union Tee  
Tube Socket Weld  
**Page No. 23**



Union Cross  
Tube Socket Weld  
**Page No. 23**

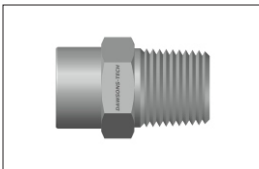

Male Connector  
Tube Socket Weld  
**Page No. 23**



Male Elbow  
Tube Socket Weld  
**Page No. 24**

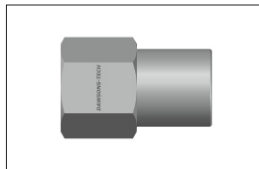

Female Connector  
Tube Socket Weld  
**Page No. 24**



Female Elbow  
Tube Socket Weld  
**Page No. 24**



Reducing Adapter  
Pipe Butt Weld to Tube Socket Weld  
**Page No . 25**

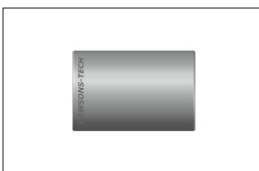

Union  
Pipe Socket Weld  
**Page No. 25**

**TUBE ADAPTERS**

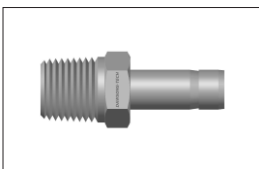

Male Adapter  
(NPT)  
**Page No. 26**

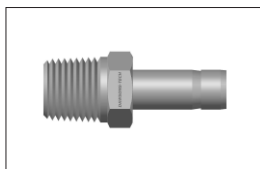

Male Adapter  
(BSPT)  
**Page No. 26**

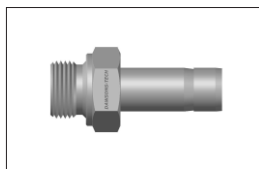

Male Adapter  
(BSP)  
**Page No. 27**

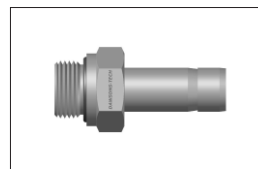

Male Adapter  
(BSP)  
**Page No. 27**

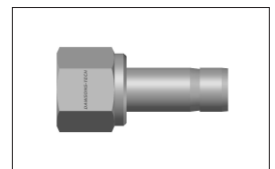

Female Adapter  
(NPT)  
**Page No . 28**

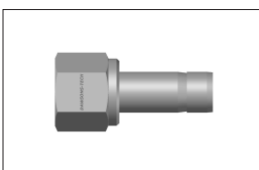

Female Adapter  
(BSPT)  
**Page No. 28**

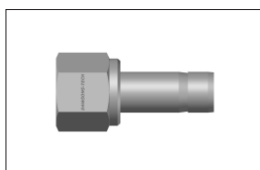

Female Adapter  
(BSP)  
**Page No. 29**

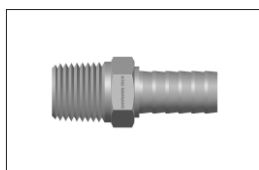

Male Hose Adapter  
(NPT)  
**Page No. 29**

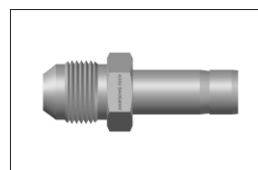

AN Male Adapter  
---  
**Page No. 29**

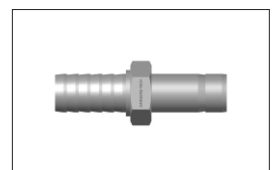

Tube To Hose Adapter  
---  
**Page No. 30**

**Hex Nipple (Male NPT Threads)**

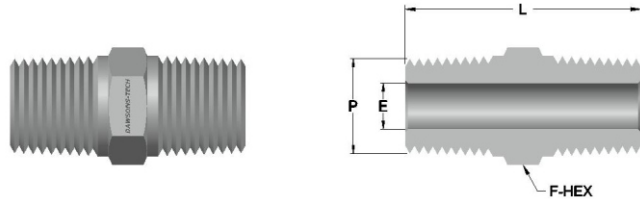

**STANDARD CONFIGURATION DIMENSIONS**

NPT Thread Size	Dimensions in mm		F-Hex (Inch)	Pressure Rating PSIG (Bar)	Dawsons-Tech Part No.	
	P	E				L
1/8		4.8	27.0	7/16	9100 (620)	HN-2N
1/4		7.1	37.0	9/16	7500 (510)	HN-4N
3/8		9.6	37.0	11/16	7200 (490)	HN-6N
1/2		11.9	48.0	7/8	6600 (450)	HN-8N
3/4		15.7	50.0	1-1/16	6400 (435)	HN-12N
1		22.4	59.0	1-3/8	4600 (313)	HN-16N

Dimensions are for reference only and are subject to change.

**Hex Nipple (Male ISO Tapered (BSPT) Threads)**

BSPT Thread Size	Dimensions in mm		F-Hex (Inch)	Pressure Rating PSIG (Bar)	Dawsons-Tech Part No.	
	P	E				L
1/8		4.8	27.0	7/16	9100 (620)	HN-2RT
1/4		7.1	37.0	9/16	7500 (510)	HN-4RT
3/8		9.6	37.0	11/16	7200 (490)	HN-6RT
1/2		11.9	48.0	7/8	6600 (450)	HN-8RT
3/4		15.7	50.0	1-1/16	6400 (435)	HN-12RT
1		22.4	59.0	1-3/8	4600 (313)	HN-16RT

Dimensions are for reference only and are subject to change.

**Hex Nipple (Male NPT to Male ISO Tapered (BSPT) Threads)**

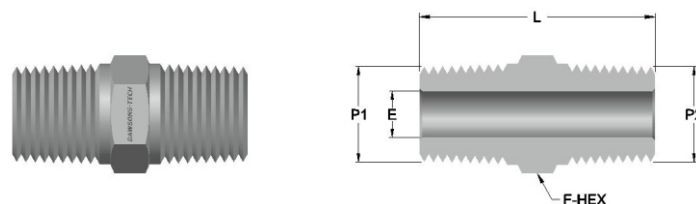

**STANDARD CONFIGURATION DIMENSIONS**

NPT Thread Size	BSPT Thread Size	Dimensions in mm		F-Hex (Inch)	Pressure Rating PSIG (Bar)	Dawsons-Tech Part No.		
		P1	P2				E	L
1/8	1/8			4.8	27.0	7/16	9100 (620)	HN-2N-2RT
1/4	1/4			7.1	37.0	9/16	7500 (510)	HN-4N-4RT
3/8	3/8			9.6	37.0	11/16	7200 (490)	HN-6N-6RT
1/2	1/2			11.9	48.0	7/8	6600 (450)	HN-8N-8RT
3/4	3/4			15.7	50.0	1-1/16	6400 (435)	HN-12N-12RT
1	1			22.4	59.0	1-3/8	4600 (313)	HN-16N-16RT

Dimensions are for reference only and are subject to change.

**Hex Nipple (Male NPT to Male ISO (BSP) Parallel Threads)**

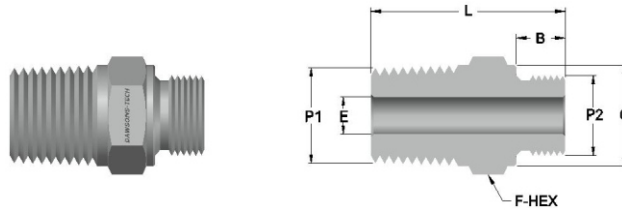

**STANDARD CONFIGURATION DIMENSIONS**

NPT Thread Size	BSP Thread Size	Dimensions in mm				F-Hex (Inch)	Pressure Rating PSIG (Bar)	Dawsons-Tech Part No.
		P1	P2	B	C			
1/8	1/8	7.1	13.7	4.1	27.2	9/16	9100 (620)	HN-2N-2RS
1/4	1/4	11.2	18.0	5.8	36.6	3/4	7500 (510)	HN-4N-4RS
3/8	3/8	11.2	21.6	7.9	37.3	7/8	7200 (490)	HN-6N-6RS
1/2	1/2	14.2	25.9	11.9	45.2	1-1/16	6600 (450)	HN-8N-8RS
3/4	3/4	15.7	31.5	15.7	49.5	1-1/4	6400 (435)	HN-12N-12RS
1	1	18.3	38.9	19.8	57.4	1-5/8	4600 (313)	HN-16N-16RS

Dimensions are for reference only and are subject to change.

**Hex Nipple (Male SAE/MS Straight Thread to Male NPT Threads)**

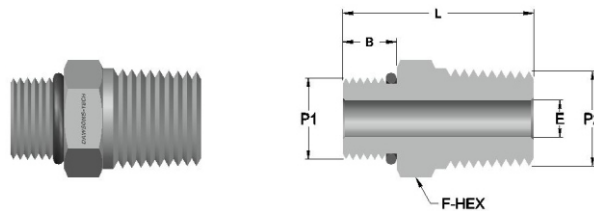

**STANDARD CONFIGURATION DIMENSIONS**

SAE/MS Thread Size	NPT Thread Size	Dimensions in mm			F-Hex (Inch)	Uniform 'O' Ring Size	Pressure Rating PSIG (Bar)	Dawsons-Tech Part No.
		B	E	L				
7/16 - 20	1/4	9.1	5.1	30.5	9/16	-907	4500 (306)	HN-7SAE-4N
9/16 - 18	3/8	9.1	7.1	32.0	11/16	-906	4500 (306)	HN-9SAE-6N
3/4 - 16	1/2	11.2	10.7	38.9	7/8	-908	4500 (306)	HN-12SAE-8N
1-1/16 - 12	3/4	15.0	15.7	44.4	1-1/4	-912	3600 (245)	HN-17SAE-12N
1-5/16 - 12	1	15.0	22.4	50.8	1-1/2	-916	2900 (198)	HN-21SAE-16N

Dimensions are for reference only and are subject to change.



**Hex Reducing Nipple (Male NPT Threads)**

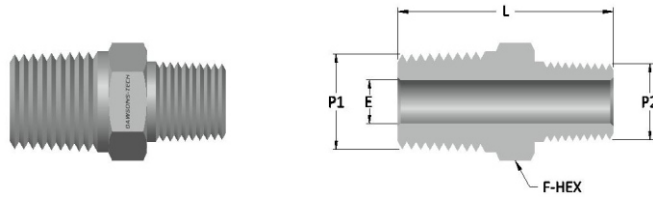

**STANDARD CONFIGURATION DIMENSIONS**

NPT Thread Size	Reduced NPT Thread Size	Dimensions in mm		F-Hex (Inch)	Pressure Rating PSIG (Bar)	Dawsons-Tech Part No.
		E	L			
P1	P2					
1/4	1/8	4.8	31.0	9/16	7500 (510)	HRN-4N-2N
3/8	1/8	4.8	31.8	11/16	7200 (490)	HRN-6N-2N
3/8	1/4	7.1	36.3	11/16	7200 (490)	HRN-6N-4N
1/2	1/8	4.8	37.3	7/8	6600 (450)	HRN-8N-2N
1/2	1/4	7.1	41.9	7/8	6600 (450)	HRN-8N-4N
1/2	3/8	9.6	41.9	7/8	6600 (450)	HRN-8N-6N
3/4	1/4	7.1	41.9	1-1/16	6400 (435)	HRN-12N-4N
3/4	3/8	9.6	41.9	1-1/16	6400 (435)	HRN-12N-6N
3/4	1/2	11.9	46.7	1-1/16	6400 (435)	HRN-12N-8N
1	1/4	7.1	49.3	1-3/8	4600 (313)	HRN-16N-4N
1	3/8	9.6	49.3	1-3/8	4600 (313)	HRN-16N-6N
1	1/2	11.9	54.1	1-3/8	4600 (313)	HRN-16N-8N
1	3/4	15.7	54.1	1-3/8	4600 (313)	HRN-16N-12N

Dimensions are for reference only and are subject to change.

**Hex Reducing Nipple (Male ISO Tapered (BSPT) Threads)**

BSPT Thread Size	Reduced BSPT Thread Size	Dimensions in mm		F-Hex (Inch)	Pressure Rating PSIG (Bar)	Dawsons-Tech Part No.
		E	L			
P1	P2					
3/8	1/4	7.1	36.3	11/16	7200 (490)	HRN-6RT-4RT
1/2	1/8	4.8	37.3	7/8	6600 (450)	HRN-8RT-2RT
1/2	3/8	9.6	41.9	7/8	6600 (450)	HRN-8RT-6RT

Dimensions are for reference only and are subject to change.

**Close Nipple (Male NPT Threads)**

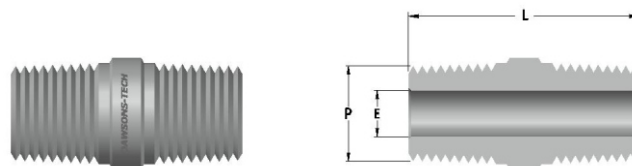

**STANDARD CONFIGURATION DIMENSIONS**

NPT Thread Size	Dimensions in mm		Pressure Rating PSIG (Bar)	Dawsons-Tech Part No.
	E	L		
P				
1/8	4.8	19.1	9100 (620)	CN-2N
1/4	7.1	28.4	7500 (510)	CN-4N
3/8	9.6	28.4	7200 (490)	CN-6N
1/2	11.9	38.1	6600 (450)	CN-8N
3/4	15.7	38.1	6400 (435)	CN-12N
1	22.4	47.8	4600 (313)	CN-16N

Dimensions are for reference only and are subject to change.

**Hex Long Nipple** (Male NPT Threads)

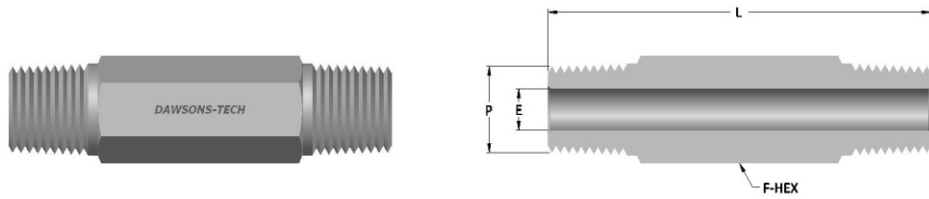

**STANDARD CONFIGURATION DIMENSIONS**

NPT Thread Size	Dimensions in mm (Inch)		F-Hex (Inch)	Pressure Rating PSIG (Bar)	Dawsons-Tech Part No.
	P	E			
1/8	4.8	38.1 (1.5)	7/16	9100 (620)	HLN-2N-24
1/8	4.8	50.8 (2.0)	7/16	9100 (620)	HLN-2N-32
1/8	4.8	63.5 (2.5)	7/16	9100 (620)	HLN-2N-40
1/8	4.8	76.2 (3.0)	7/16	9100 (620)	HLN-2N-48
1/4	7.1	38.1 (1.5)	9/16	7500 (510)	HLN-4N-24
1/4	7.1	50.8 (2.0)	9/16	7500 (510)	HLN-4N-32
1/4	7.1	63.5 (2.5)	9/16	7500 (510)	HLN-4N-40
1/4	7.1	76.2 (3.0)	9/16	7500 (510)	HLN-4N-48
1/4	7.1	101.6 (4.0)	9/16	7500 (510)	HLN-4N-64
3/8	9.6	38.1 (1.5)	11/16	7200 (490)	HLN-6N-24
3/8	9.6	50.8 (2.0)	11/16	7200 (490)	HLN-6N-32
3/8	9.6	63.5 (2.5)	11/16	7200 (490)	HLN-6N-40
3/8	9.6	76.2 (3.0)	11/16	7200 (490)	HLN-6N-48
3/8	9.6	101.6 (4.0)	11/16	7200 (490)	HLN-6N-64
1/2	11.9	50.8 (2.0)	7/8	6600 (450)	HLN-8N-32
1/2	11.9	76.2 (3.0)	7/8	6600 (450)	HLN-8N-48
1/2	11.9	101.6 (4.0)	7/8	6600 (450)	HLN-8N-64
1/2	11.9	152.4 (6.0)	7/8	6600 (450)	HLN-8N-96
3/4	15.7	50.8 (2.0)	1-1/16	6400 (435)	HLN-12N-32
3/4	15.7	76.2 (3.0)	1-1/16	6400 (435)	HLN-12N-48
3/4	15.7	101.6 (4.0)	1-1/16	6400 (435)	HLN-12N-64
1	22.4	76.2 (3.0)	1-3/8	4600 (313)	HLN-16N-48
1	22.4	101.6 (4.0)	1-3/8	4600 (313)	HLN-16N-64

Dimensions are for reference only and are subject to change.

**Adapter** (Female to Male NPT Threads)

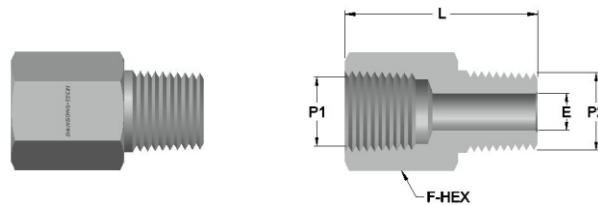

**STANDARD CONFIGURATION DIMENSIONS**

Female NPT Thread Size	Male NPT Thread Size	Dimensions in mm		F-Hex (Inch)	Pressure Rating PSIG (Bar)	Dawsons-Tech Part No.
		P1	P2			
1/8	1/8	4.8	27.9	9/16	6400 (435)	A-2N
1/4	1/4	7.1	35.6	3/4	6600 (450)	A-4N
3/8	3/8	9.6	38.4	7/8	5300 (360)	A-6N
1/2	1/2	11.9	49.3	1-1/16	5200 (354)	A-8N
3/4	3/4	15.7	51.3	1-1/4	4300 (292)	A-12N
1	1	22.1	57.6	1-5/8	4500 (306)	A-16N

Dimensions are for reference only and are subject to change.

**Adapter** (Female to Male BSPT Threads)

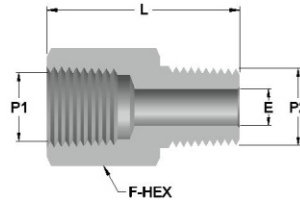
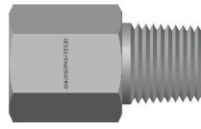

**STANDARD CONFIGURATION DIMENSIONS**

Female BSPT Thread Size	Male BSPT Thread Size	Dimensions in mm		F-Hex (Inch)	Pressure Rating PSIG (Bar)	Dawsons-Tech Part No.
		P1	P2			
1/8	1/8	4.8	27.9	9/16	6400 (435)	A-2RT
1/4	1/4	7.1	35.6	3/4	6600 (450)	A-4RT
3/8	3/8	9.6	38.4	7/8	5300 (360)	A-6RT
1/2	1/2	11.9	49.3	1-1/16	5200 (354)	A-8RT

Dimensions are for reference only and are subject to change.

**Adapter** (Female NPT to Male ISO Tapered (BSPT) Threads)

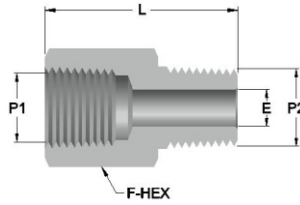
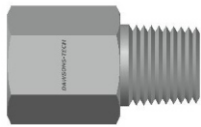

**STANDARD CONFIGURATION DIMENSIONS**

Female NPT Thread Size	Male BSPT Thread Size	Dimensions in mm		F-Hex (Inch)	Pressure Rating PSIG (Bar)	Dawsons-Tech Part No.
		P1	P2			
1/8	1/8	4.8	27.7	9/16	6100 (415)	A-2N-2RT
1/4	1/4	7.1	36.1	3/4	6200 (422)	A-4N-4RT
3/8	3/8	9.6	38.1	7/8	5000 (340)	A-6N-6RT
1/2	1/2	11.9	49.3	1-1/16	4600 (315)	A-8N-8RT
3/4	3/4	15.7	51.3	1-1/4	4300 (292)	A-12N-12R
1	1	22.4	58.4	1-5/8	4100 (280)	A-16N-16RT

Dimensions are for reference only and are subject to change.

**Adapter** (Female ISO Tapered (BSPT) to Male NPT Threads)

Female BSPT Thread Size	Male NPT Thread Size	Dimensions in mm		F-Hex (Inch)	Pressure Rating PSIG (Bar)	Dawsons-Tech Part No.
		P1	P2			
1/4	1/4	7.1	36.3	3/4	6200 (422)	A-4RT-4N
3/8	3/8	9.6	38.4	7/8	5000 (340)	A-6RT-6N
1/2	1/2	11.9	49.8	1-1/16	4600 (315)	A-8RT-8N

Dimensions are for reference only and are subject to change.

**Adapter** (Female NPT to Male ISO Parallel (BSP) Threads)

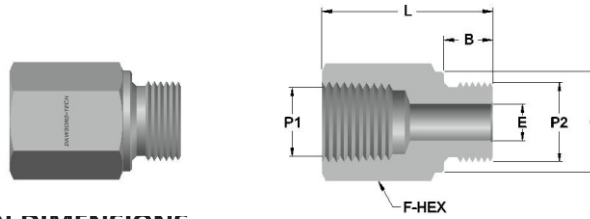

**STANDARD CONFIGURATION DIMENSIONS**

Female NPT Thread Size	Male BSP Thread Size	Dimensions in mm				F-Hex (Inch)	Pressure Rating PSIG (Bar)	Dawsons-Tech Part No.
		P1	P2	B	C			
1/8	1/8	7.1	13.7	4.1	25.1	9/16	6100 (415)	A-2N-2RS
1/4	1/4	11.2	18.0	5.8	33.5	3/4	6200 (422)	A-4N-4RS
3/8	3/8	11.2	21.6	7.9	35.8	7/8	5000 (340)	A-6N-6RS
1/2	1/2	14.2	25.9	11.9	44.2	1-1/16	4600 (315)	A-8N-8RS
3/4	3/4	15.7	31.5	15.7	48.0	1-1/4	4300 (292)	A-12N-12RS
1	1	18.3	38.9	19.8	53.3	1-5/8	4100 (280)	A-16N-16RS

Dimensions are for reference only and are subject to change.

**Adapter** (Female NPT to Male SAE/MS Straight Threads)

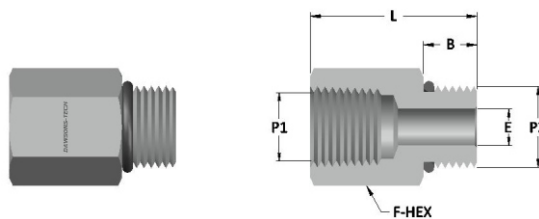

**STANDARD CONFIGURATION DIMENSIONS**

NPT Thread Size	Male SAE / MS Thread Size	Dimensions in mm			F-Hex (Inch)	Uniform 'O' Ring Size	Pressure Rating PSIG (Bar)	Dawsons-Tech Part No.
		B	E	L				
1/4	7/16 - 20	9.1	5.1	33.5	3/4	-904	4500 (306)	A-4N-7SAE
3/8	9/16 - 18	9.9	7.1	35.3	7/8	-906	4500 (306)	A-6N-9SAE
1/2	3/4 - 16	11.2	10.6	44.7	1-1/16	-908	4500 (306)	A-8N-12SAE
3/4	1-1/16 - 12	15.0	16.7	50.5	1-1/4	-912	3600 (245)	A-12N-17SAE
1	1-5/16 - 12	15.0	22.3	53.8	1-5/8	-916	2900 (198)	A-16N-21SAE

Dimensions are for reference only and are subject to change.

**Reducing Adapter (Female to Male NPT Threads)**

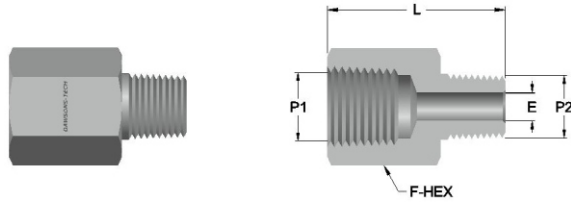

**STANDARD CONFIGURATION DIMENSIONS**

Female NPT Thread Size	Reduced Male NPT Thread Size	Dimensions in mm		F-Hex (Inch)	Pressure Rating PSIG (Bar)	Dawsons-Tech Part No.
		P1	P2			
1/4	1/8	4.8	32.0	3/4	6600 (450)	RA-4N-2N
3/8	1/8	4.8	33.8	7/8	5300 (360)	RA-6N-2N
3/8	1/4	7.1	38.1	7/8	5300 (360)	RA-6N-4N
1/2	1/8	4.8	40.1	1-1/16	5200 (354)	RA-8N-2N
1/2	1/4	7.1	44.7	1-1/16	5200 (354)	RA-8N-4N
1/2	3/8	9.6	44.4	1-1/16	5200 (354)	RA-8N-6N
3/4	1/4	7.1	47.0	1-1/4	4300 (292)	RA-12N-4N
3/4	3/8	9.6	46.2	1-1/4	4300 (292)	RA-12N-6N
3/4	1/2	11.9	51.3	1-1/4	4300 (292)	RA-12N-8N
1	1/4	7.1	49.8	1-5/8	4500 (306)	RA-16N-4N
1	1/2	11.9	54.9	1-5/8	4500 (306)	RA-16N-8N
1	3/4	15.7	55.1	1-5/8	4500 (306)	RA-16N-12N

Dimensions are for reference only and are subject to change.

**Reducing Adapter (Female to Male ISO Tapered (BSPT) Threads)**

Female BSPT Thread Size	Reduced Male BSPT Thread Size	Dimensions in mm		F-Hex (Inch)	Pressure Rating PSIG (Bar)	Dawsons-Tech Part No.
		P1	P2			
1/4	1/8	4.8	32.0	13/16	6600 (450)	RA-4RT-2RT
3/8	1/4	7.1	38.1	7/8	5300 (360)	RA-6RT-4RT
1/2	1/4	7.1	44.7	1-1/16	5200 (354)	RA-8RT-4RT
1/2	3/8	9.6	44.4	1-1/16	5200 (354)	RA-8RT-6RT

Dimensions are for reference only and are subject to change.

**Reducing Adapter (Male SAE/MS to Female SAE/MS Straight Threads)**

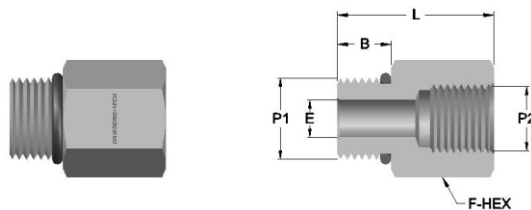

**STANDARD CONFIGURATION DIMENSIONS**

Male SAE/MS Thread Size	Female SAE/MS Thread Size	Dimensions in mm			F-Hex (Inch)	Uniform 'O' Ring Size	Pressure Rating PSIG (Bar)	Dawsons-Tech Part No.
		B	E	L				
9/16 - 18	7/16 - 20	9.9	7.1	31.0	15/16	-906	4500 (306)	RA-9-7SAE
3/4 - 16	7/16 - 20	11.2	9.9	24.9	7/8	-908	4500 (306)	RA-12-7SAE
3/4 - 16	9/16 - 18	11.2	10.6	35.8	1	-908	4500 (306)	RA-12-9SAE
7/8 - 14	9/16 - 18	12.7	12.7	32.8	1	-910	3600 (245)	RA-14-9SAE
7/8 - 14	3/4 - 16	12.7	12.7	39.6	1-3/16	-910	3600 (245)	RA-14-12SAE
1-1/16 - 12	3/4 - 16	15.0	16.7	38.6	1-1/4	-912	3600 (245)	RA-17-12SAE
1-5/16 - 12	1-1/16 - 12	15.0	22.3	49.3	1-5/8	-916	2900 (198)	RA-21-17SAE

Dimensions are for reference only and are subject to change.

**Reducing Bushing (Male to Female NPT Threads)**

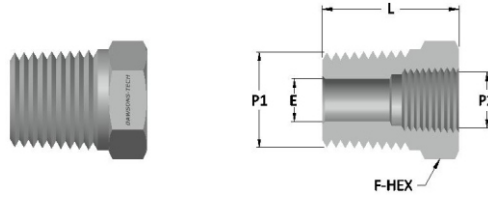

**STANDARD CONFIGURATION DIMENSIONS**

Male NPT Thread Size	Reduced Female NPT Thread Size	Dimensions in mm		F-Hex (Inch)	Pressure Rating PSIG (Bar)	Dawsons-Tech Part No.
		E	L			
P1	P2					
1/4	1/8	7.1	26.9	9/16	6000 (408)	RB-4N-2N
3/8	1/8	8.6	21.8	11/16	6400 (435)	RB-6N-2N
3/8	1/4	9.6	30.2	3/4	5300 (360)	RB-6N-4N
1/2	1/8	8.6	27.4	7/8	6600 (450)	RB-8N-2N
1/2	1/4	11.4	27.4	7/8	6400 (435)	RB-8N-4N
1/2	3/8	11.9	35.8	7/8	4600 (315)	RB-8N-6N
3/4	1/4	11.4	27.4	1-1/16	6400 (435)	RB-12N-4N
3/4	3/8	15.0	27.4	1-1/16	5300 (360)	RB-12N-6N
3/4	1/2	15.7	41.4	1-1/16	4900 (333)	RB-12N-8N
1	1/4	11.4	34.8	1-3/8	4600 (315)	RB-16N-4N
1	3/8	15.0	34.8	1-3/8	4600 (315)	RB-16N-6N
1	1/2	18.5	34.8	1-3/8	4600 (315)	RB-16N-8N
1	3/4	22.4	47.0	1-3/8	4200 (286)	RB-16N-12N

Dimensions are for reference only and are subject to change.

**Reducing Bushing (Male to Female ISO Tapered (BSPT) Threads)**

Male BSPT Thread Size	Reduced Female BSPT Thread Size	Dimensions in mm		F-Hex (Inch)	Pressure Rating PSIG (Bar)	Dawsons-Tech Part No.
		E	L			
P1	P2					
1/4	1/8	7.1	26.9	9/16	6000 (408)	RB-4RT-2RT
3/8	1/4	9.6	30.2	3/4	5300 (360)	RB-6RT-4RT
1/2	1/4	11.4	27.4	7/8	6400 (435)	RB-8RT-4RT
1/2	3/8	11.9	35.8	7/8	4600 (315)	RB-8RT-6RT

Dimensions are for reference only and are subject to change.

**Hex Coupling (Female NPT Threads)**

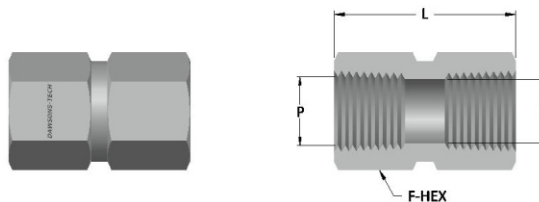

**STANDARD CONFIGURATION DIMENSIONS**

NPT Thread Size	Dimensions in mm		F-Hex (Inch)	Pressure Rating PSIG (Bar)	Dawsons-Tech Part No.
	E	L			
P					
1/8	8.6	20.6	9/16	6400 (435)	HC-2N
1/4	11.4	30.2	3/4	6600 (450)	HC-4N
3/8	15.0	33.3	7/8	5300 (360)	HC-6N
1/2	18.5	39.6	1-1/16	5200 (354)	HC-8N
3/4	23.9	41.1	1-1/4	4300 (292)	HC-12N
1	29.7	50.8	1-5/8	4500 (306)	HC-16N

Dimensions are for reference only and are subject to change.

**Hex Coupling (Female ISO Tapered (BSPT) Threads)**

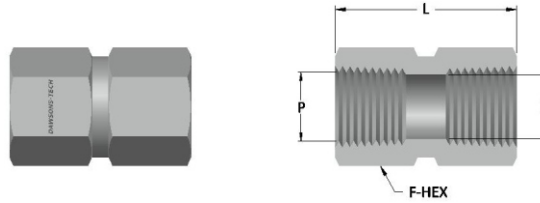

**STANDARD CONFIGURATION DIMENSIONS**

BSPT Thread Size	Dimensions in mm		F-Hex (Inch)	Pressure Rating PSIG (Bar)	Dawsons-Tech Part No.	
	P	E				L
1/8		8.4	20.6	9/16	6400 (435)	HC-2RT
1/4		11.2	30.2	3/4	6600 (450)	HC-4RT
3/8		14.7	33.3	7/8	5300 (360)	HC-6RT
1/2		18.3	39.6	1-1/16	5200 (354)	HC-8RT

Dimensions are for reference only and are subject to change.

**Hex Reducing Coupling (Female NPT Threads)**

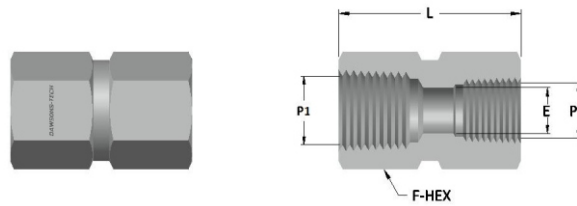

**STANDARD CONFIGURATION DIMENSIONS**

NPT Thread Size	Reduced NPT Thread Size	Dimensions in mm		F-Hex (Inch)	Pressure Rating PSIG (Bar)	Dawsons-Tech Part No.		
		P1	P2				E	L
1/4	1/8			8.6	31.0	3/4	6600 (450)	HRC-4N-2N
3/8	1/8			8.6	31.0	7/8	5300 (360)	HRC-6N-2N
3/8	1/4			11.4	35.1	7/8	5300 (360)	HRC-6N-4N
1/2	1/8			8.6	39.6	1-1/16	5200 (354)	HRC-8N-2N
1/2	1/4			11.4	44.4	1-1/16	5200 (354)	HRC-8N-4N
1/2	3/8			15.0	45.0	1-1/16	5200 (354)	HRC-8N-6N
3/4	1/4			11.4	46.0	1-1/4	4300 (292)	HRC-12N-4N
3/4	3/8			15.0	46.0	1-1/4	4300 (292)	HRC-12N-6N
3/4	1/2			18.5	52.3	1-1/4	4300 (292)	HRC-12N-8N
1	1/2			18.5	55.6	1-5/8	4500 (306)	HRC-16N-8N
1	3/4			23.9	57.2	1-5/8	4500 (306)	HRC-16N-12N

Dimensions are for reference only and are subject to change.

**Hex Reducing Coupling (Female ISO Tapered (BSPT) Threads)**

BSPT Thread Size	Reduced BSPT Thread Size	Dimensions in mm		F-Hex (Inch)	Pressure Rating PSIG (Bar)	Dawsons-Tech Part No.		
		P1	P2				E	L
3/8	1/4			11.2	35.1	7/8	5300 (360)	HRC-6RT-4RT
1/2	1/4			11.2	44.4	1-1/16	4900 (333)	HRC-8RT-2RT
1/2	3/8			14.7	45.2	1-1/16	4900 (333)	HRC-8RT-6RT

Dimensions are for reference only and are subject to change.

**Male Elbow (Male NPT Threads)**

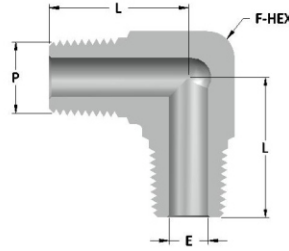

**STANDARD CONFIGURATION DIMENSIONS**

NPT Thread Size	Dimensions in mm		F-Hex (Inch)	Pressure Rating PSIG (Bar)	Dawsons-Tech Part No.
	P	E			
1/8	4.8	19.8	7/16	9100 (620)	ME-2N
1/4	7.1	27.7	9/16	7500 (510)	ME-4N
3/8	9.6	31.0	11/16	7200 (490)	ME-6N
1/2	11.9	37.4	7/8	5800 (395)	ME-8N
3/4	15.7	40.4	1-1/16	6400 (438)	ME-12N
1	22.4	50.1	1-5/16	4600 (315)	ME-16N

Dimensions are for reference only and are subject to change.

**Male Tee (Male NPT Threads)**

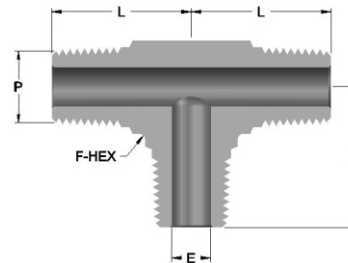
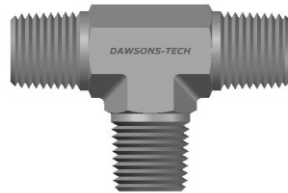

**STANDARD CONFIGURATION DIMENSIONS**

NPT Thread Size	Dimensions in mm		F-Hex (Inch)	Pressure Rating PSIG (Bar)	Dawsons-Tech Part No.
	P	E			
1/8	4.8	19.8	7/16	5500 (375)	MT-2N
1/4	7.1	27.7	9/16	5600 (380)	MT-4N
3/8	9.6	31.0	11/16	5600 (380)	MT-6N
1/2	11.9	37.4	7/8	4500 (306)	MT-8N
3/4	15.7	40.4	1-1/16	3500 (238)	MT-12N
1	22.4	50.1	1-5/16	3500 (238)	MT-16N

Dimensions are for reference only and are subject to change.

**Female Elbow (Female NPT Threads)**

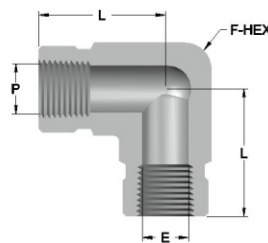

**STANDARD CONFIGURATION DIMENSIONS**

NPT Thread Size	Dimensions in mm		F-Hex (Inch)	Pressure Rating PSIG (Bar)	Dawsons-Tech Part No.
	P	E			
1/8	8.6	16.7	9/16	5500 (375)	FE-2N
1/4	11.4	22.3	3/4	5600 (380)	FE-4N
3/8	15.0	25.9	7/8	5000 (340)	FE-6N
1/2	18.5	31.2	1-1/16	4500 (306)	FE-8N
3/4	23.9	34.5	1-5/16	3500 (238)	FE-12N
1	29.7	41.4	1-5/8	3900 (270)	FE-16N

Dimensions are for reference only and are subject to change.



**Female Elbow** (Female ISO Tapered (BSPT) Threads)

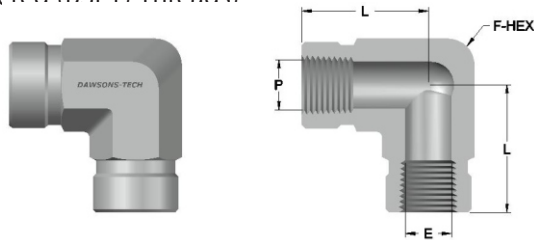

**STANDARD CONFIGURATION DIMENSIONS**

BSPT Thread Size	Dimensions in mm		F-Hex (Inch)	Pressure Rating PSIG (Bar)	Dawsons-Tech Part No.
	P	E			
1/4	11.4	22.3	3/4	5600 (380)	FE-4RT
3/8	15.0	25.9	7/8	5000 (340)	FE-6RT
1/2	18.5	31.2	1-1/16	4500 (306)	FE-8RT

Dimensions are for reference only and are subject to change.

**Female Tee** (Female NPT Threads)

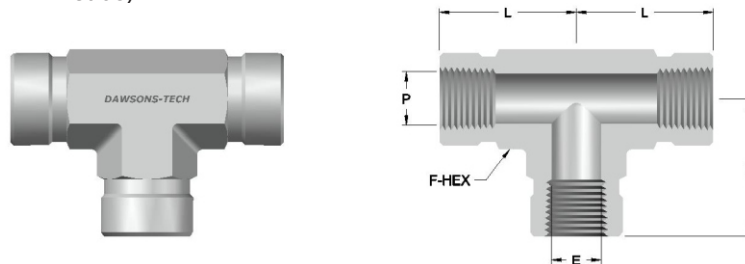

**STANDARD CONFIGURATION DIMENSIONS**

NPT Thread Size	Dimensions in mm		F-Hex (Inch)	Pressure Rating PSIG (Bar)	Dawsons-Tech Part No.
	P	E			
1/8	8.6	16.7	9/16	5500 (375)	FT-2N
1/4	11.4	22.3	3/4	5600 (380)	FT-4N
3/8	15.0	25.9	7/8	5600 (380)	FT-6N
1/2	18.5	31.2	1-1/16	4500 (306)	FT-8N
3/4	23.9	34.5	1-5/16	3500 (238)	FT-12N
1	29.7	41.4	1-5/8	3900 (265)	FT-16N

Dimensions are for reference only and are subject to change.

**Female Tee** (Female ISO Tapered (BSPT) Threads)

BSPT Thread Size	Dimensions in mm		F-Hex (Inch)	Pressure Rating PSIG (Bar)	Dawsons-Tech Part No.
	P	E			
1/4	11.2	22.3	3/4	5600 (380)	FT-4RT
3/8	14.7	25.9	7/8	5600 (380)	FT-6RT
1/2	18.3	31.2	1-1/16	4500 (306)	FT-8RT

Dimensions are for reference only and are subject to change.

**Female Cross** (Female NPT Threads)

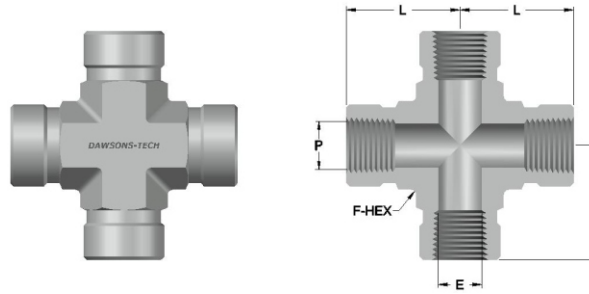

**STANDARD CONFIGURATION DIMENSIONS**

NPT Thread Size	Dimensions in mm		F-Hex (Inch)	Pressure Rating PSIG (Bar)	Dawsons-Tech Part No.
	P	E			
1/8	8.6	16.7	9/16	5500 (375)	FC-2N
1/4	11.4	22.3	3/4	5600 (380)	FC-4N
3/8	15.0	25.9	7/8	5600 (380)	FC-6N
1/2	18.5	31.2	1-1/16	4500 (306)	FC-8N
3/4	23.9	34.5	1-5/16	3500 (238)	FC-12N
1	29.7	41.4	1-5/8	3900 (265)	FC-16N

Dimensions are for reference only and are subject to change.

**Street Elbow** (Female to Male NPT Threads)

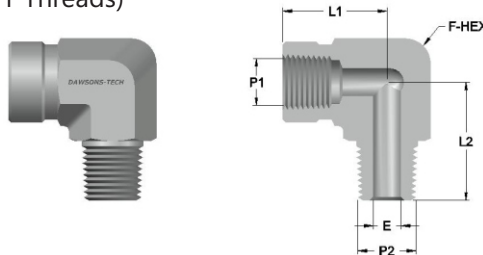

**STANDARD CONFIGURATION DIMENSIONS**

Female NPT Thread Size	Male NPT Thread Size	Dimensions in mm			F-Hex (Inch)	Pressure Rating PSIG (Bar)	Dawsons-Tech Part No.
		E	L1	L2			
P1	P2						
1/8	1/8	4.8	16.7	19.8	9/16	5500 (375)	SE-2N
1/4	1/4	7.1	22.3	27.7	3/4	5600 (380)	SE-4N
3/8	3/8	9.6	25.9	31.0	7/8	5600 (380)	SE-6N
1/2	1/2	11.9	31.2	37.3	1-1/16	4500 (306)	SE-8N
3/4	3/4	15.7	34.5	40.4	1-5/16	3500 (238)	SE-12N
1	1	22.4	41.4	50.1	1-5/8	3900 (265)	SE-16N

Dimensions are for reference only and are subject to change.

**Reducing Street Elbow** (Female to Male NPT Threads)

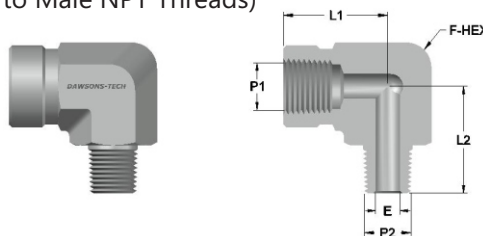

**STANDARD CONFIGURATION DIMENSIONS**

Female NPT Thread Size	Reduced Male NPT Thread Size	Dimensions in mm			F-Hex (Inch)	Pressure Rating PSIG (Bar)	Dawsons-Tech Part No.
		E	L1	L2			
P1	P2						
1/4	1/8	4.8	22.3	22.8	3/4	5500 (375)	RSE-4N-2N
3/8	1/4	7.1	25.6	31.0	7/8	5500 (375)	RSE-6N-4N
1/2	1/4	7.1	32.5	32.5	1-1/16	4500 (306)	RSE-8N-4N
1/2	3/8	9.6	32.5	32.5	1-1/16	4500 (306)	RSE-8N-6N

Dimensions are for reference only and are subject to change.

**Street Tee** (Female and Male NPT Threads)

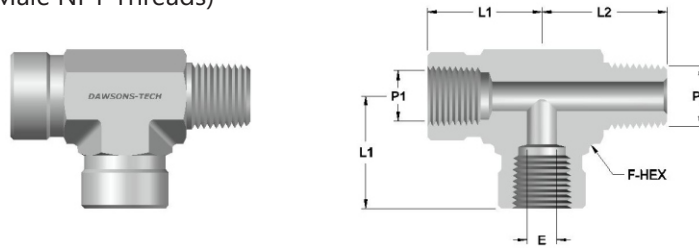

**STANDARD CONFIGURATION DIMENSIONS**

Female NPT Thread Size	Male NPT Thread Size	Dimensions in mm			F-Hex (Inch)	Pressure Rating PSIG (Bar)	Dawsons-Tech Part No.
		P1	P2	E			
1/8	1/8	4.8	16.7	19.8	9/16	5500 (375)	ST-2N
1/4	1/4	7.1	22.3	27.7	3/4	5600 (380)	ST-4N
3/8	3/8	9.6	25.9	31.0	7/8	5600 (380)	ST-6N
1/2	1/2	11.9	31.2	37.3	1-1/16	4500 (306)	ST-8N
3/4	3/4	15.7	34.5	40.4	1-5/16	3500 (238)	ST-12N
1	1	22.4	41.4	50.1	1-5/8	3900 (265)	ST-16N

Dimensions are for reference only and are subject to change.

**Branch Tee** (Female and Male NPT Threads)

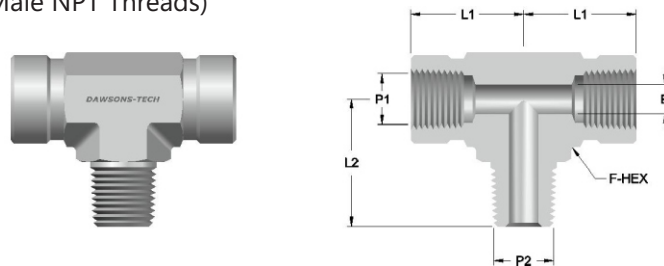

**STANDARD CONFIGURATION DIMENSIONS**

Female NPT Thread Size	Male NPT Thread Size	Dimensions in mm			F-Hex (Inch)	Pressure Rating PSIG (Bar)	Dawsons-Tech Part No.
		P1	P2	E			
1/8	1/8	4.8	16.7	19.8	9/16	5500 (375)	BT-2N
1/4	1/4	7.1	22.3	27.7	3/4	5600 (380)	BT-4N
3/8	3/8	9.6	25.9	31.0	7/8	5600 (380)	BT-6N
1/2	1/2	11.9	31.2	37.3	1-1/16	4500 (306)	BT-8N
3/4	3/4	15.7	34.5	40.4	1-5/16	3500 (238)	BT-12N
1	1	22.4	41.4	50.1	1-5/8	3900 (265)	BT-16N

Dimensions are for reference only and are subject to change.

**Union Ball Joint** (Female NPT Threads)

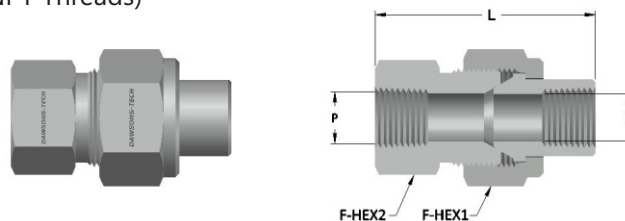

**STANDARD CONFIGURATION DIMENSIONS**

NPT Thread Size	Dimensions in mm		F-Hex1 (Inch)	F-Hex2 (Inch)	Pressure Rating PSIG (Bar)	Dawsons-Tech Part No.
	P	E				
1/8	6.8	46.0	1-1/8	1-1/16	8400 (572)	UBJ-2N
1/4	9.1	59.4	1-3/8	1-3/16	6600 (450)	UBJ-4N
3/8	13.2	63.5	1-1/8	1-5/16	5300 (360)	UBJ-6N
1/2	15.7	68.3	1-3/4	1-5/8	6000 (408)	UBJ-8N
3/4	22.4	79.2	2-1/8	1-7/8	4600 (313)	UBJ-12N
1	26.2	90.4	2-1/2	2-3/8	6800 (462)	UBJ-16N

Dimensions are for reference only and are subject to change.

**Pipe Cap** (Female NPT Threads)

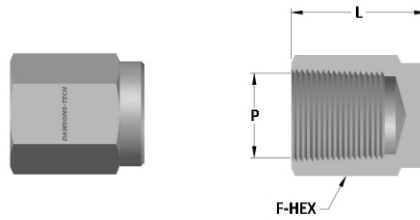

**STANDARD CONFIGURATION DIMENSIONS**

NPT Thread Size	Dimensions in mm		F-Hex (Inch)	Pressure Rating PSIG (Bar)	Dawsons-Tech Part No.
	P	L			
1/8	19.1		9/16	6400 (435)	PC-2N
1/4	23.1		3/4	6600 (450)	PC-4N
3/8	26.2		7/8	5300 (360)	PC-6N
1/2	34.0		1-1/16	5200 (354)	PC-8N
3/4	36.6		1-1/4	4300 (292)	PC-12N
1	41.1		1-5/8	4500 (306)	PC-16N

Dimensions are for reference only and are subject to change.

**Pipe Plug** (Male NPT Threads)

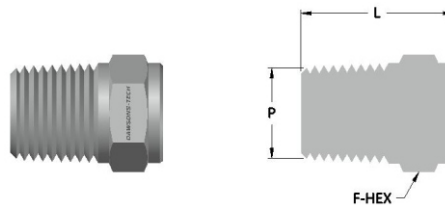

**STANDARD CONFIGURATION DIMENSIONS**

NPT Thread Size	Dimensions in mm		F-Hex (Inch)	Pressure Rating PSIG (Bar)	Dawsons-Tech Part No.
	P	L			
1/8	19.1		7/16	9700 (660)	PP-2N
1/4	24.4		9/16	8000 (544)	PP-4N
3/8	25.1		11/16	7600 (517)	PP-6N
1/2	30.7		7/8	7000 (477)	PP-8N
3/4	30.7		1-1/16	6800 (463)	PP-12N
1	38.1		1-3/8	4900 (333)	PP-16N

Dimensions are for reference only and are subject to change.

**Hollow Hex Plug** (Male SAE/MS Straight Threads)

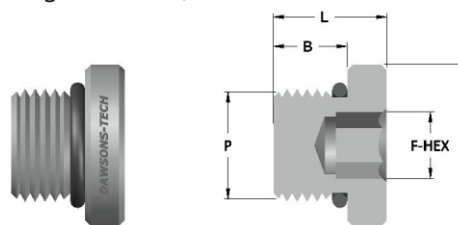

**STANDARD CONFIGURATION DIMENSIONS**

NPT Thread Size	Dimensions in mm			F-Hex (Inch)	Uniform 'O' Ring Size	Dawsons-Tech Part No.
	B	C	L			
7/16 - 20	9.1	14.2	11.4	3/16	-904	HHPST-7SAE
9/16 - 18	9.9	17.5	12.2	1/4	-906	HHPST-9SAE
3/4 - 16	11.2	22.4	14.2	5/16	-908	HHPST-12SAE
1-1/16 - 12	15.0	31.8	19.1	9/16	-912	HHPST-17SAE
1-5/16 - 12	15.0	38.1	19.1	5/8	-916	HHPST-21SAE

Dimensions are for reference only and are subject to change.

**Hollow Hex Plug (Male NPT Threads)**

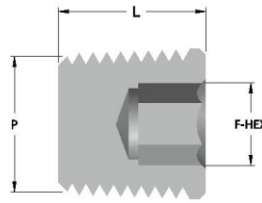

**STANDARD CONFIGURATION DIMENSIONS**

NPT Thread Size	Dimensions in mm		F-Hex (Inch)	Dawsons-Tech Part No.
P	L			
1/8	10.4		3/16	HHP-2N
1/4	15.0		1/4	HHP-4N
3/8	15.0		5/16	HHP-6N
1/2	19.3		3/8	HHP-8N

Dimensions are for reference only and are subject to change.

**Hollow Hex Plug (Male BSPT Threads)**

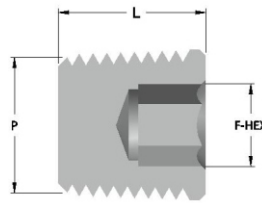

**STANDARD CONFIGURATION DIMENSIONS**

BSPT Thread Size	Dimensions in mm		F-Hex (Inch)	Dawsons-Tech Part No.
P	L			
1/8	10.4		3/16	HHP-2RT
1/4	15.0		1/4	HHP-4RT
3/8	15.0		5/16	HHP-6RT
1/2	19.3		3/8	HHP-8RT

Dimensions are for reference only and are subject to change.

**Hex Head Plug (Male SAE/MS Straight Threads)**

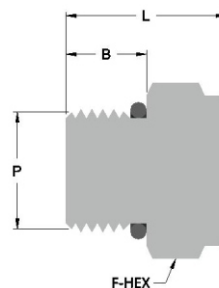

**STANDARD CONFIGURATION DIMENSIONS**

SAE/MS Thread Size	Dimensions in mm		F-Hex (Inch)	Uniform 'O' Ring Size	Dawsons-Tech Part No.
P	B	L			
7/16 - 20	9.1	19.3	9/16	-904	HHPSAE-7
9/16 - 18	9.9	20.8	11/16	-906	HHPSAE-9
3/4 - 16	11.2	22.6	7/8	-908	HHPSAE-12
1-1/16 - 12	15.0	28.4	1-1/4	-912	HHPSAE-17
1-5/16 - 12	15.0	30.0	1-1/2	-916	HHPSAE-21

Dimensions are for reference only and are subject to change.

## Reducing Adapter (Tube Butt Weld to Tube Socket Weld)

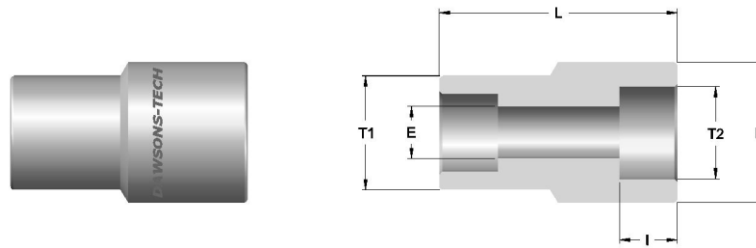

### STANDARD CONFIGURATION DIMENSIONS

Tube OD	Tube OD	Dimensions in mm				Pressure Rating PSIG (Bar)	Dawsons-Tech Part No.
T1	T2	D	Min. Opening E	I	L		
1/4	1/8	7.4	2.3	2.5	14.9	12,600 (860)	RA-4TBW-2TSW
3/8	1/4	12.2	4.8	7.1	19.1	8200 (560)	RA-6TBW-4TSW
1/2	1/4	12.7	4.8	7.1	22.4	7500 (510)	RA-8TBW-4TSW
1/2	3/8	15.2	8.4	7.9	22.4	7500 (510)	RA-8TBW-6TSW
3/4	1/2	19.1	10.4	9.7	28.4	6300 (430)	RA-12TBW-8TSW
1	1/2	18.5	10.4	9.7	35.1	5300 (360)	RA-16TBW-8TSW

Dimensions are for reference only and are subject to change.

## Union (Tube Socket Weld)

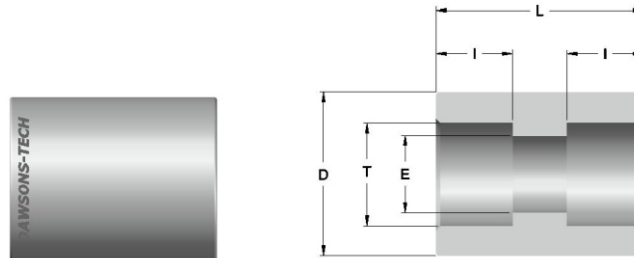

### STANDARD CONFIGURATION DIMENSIONS

Tube OD	Dimensions in mm				Pressure Rating PSIG (Bar)	Dawsons-Tech Part No.
T	D	Min. Opening E	I	L		
1/4	12.2	4.8	7.1	19.1	10,300 (700)	U-4TSW
3/8	15.2	7.1	7.9	22.4	8100 (550)	U-6TSW
1/2	18.5	10.4	9.7	26.9	6600 (450)	U-8TSW
3/4	28.4	15.7	11.2	33.3	5900 (400)	U-12TSW
1	34.6	22.4	15.7	36.6	5600 (380)	U-16TSW

Dimensions are for reference only and are subject to change.

## Union Elbow (Tube Socket Weld)

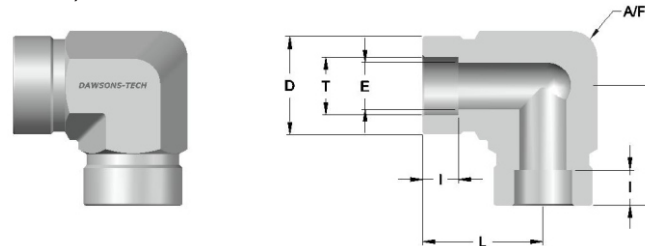

### STANDARD CONFIGURATION DIMENSIONS

Tube OD	Dimensions in mm				A/F (Inch)	Pressure Rating PSIG (Bar)	Dawsons-Tech Part No.
T	D	Min. Opening E	I	L			
1/4	13.5	4.8	7.1	21.8	9/16	10,300 (700)	UE-4TSW
3/8	17.5	7.1	7.9	25.4	11/16	8100 (550)	UE-6TSW
1/2	20.6	10.4	9.7	29.7	13/16	6600 (450)	UE-8TSW
3/4	28.6	15.7	11.2	39.6	1-1/8	5900 (400)	UE-12TSW
1	36.8	22.4	15.7	48.8	1-11/16	5600 (380)	UE-16TSW

Dimensions are for reference only and are subject to change.

## Union Tee (Tube Socket Weld)

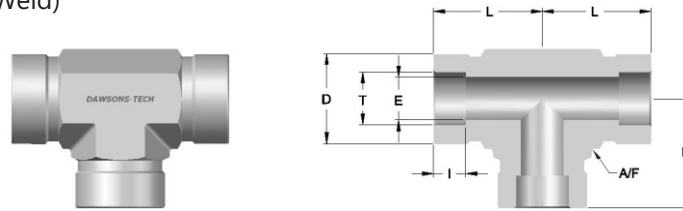

### STANDARD CONFIGURATION DIMENSIONS

Tube OD	Dimensions in mm				A/F (Inch)	Pressure Rating PSIG (Bar)	Dawsons-Tech Part No.
T	D	Min. Opening E	I	L			
1/8	9.0	2.3	2.5	15.0	7/16	12,600 (860)	UT-4TSW
1/4	13.5	4.8	7.1	21.8	9/16	10,300 (700)	UT-4TSW
3/8	17.5	7.1	7.9	26.4	11/16	8100 (550)	UT-6TSW
1/2	20.6	10.4	9.7	29.7	13/16	6600 (450)	UT-8TSW
3/4	28.6	15.7	11.2	39.6	1-1/8	5900 (400)	UT-12TSW
1	36.8	22.4	15.7	48.8	1-11/16	5600 (380)	UT-16TSW

Dimensions are for reference only and are subject to change.

## Union Cross (Tube Socket Weld)

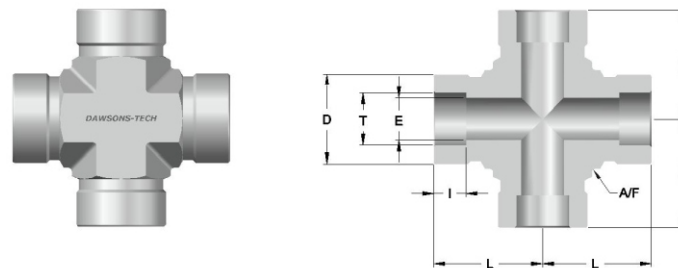

### STANDARD CONFIGURATION DIMENSIONS

Tube OD	Dimensions in mm				A/F (Inch)	Pressure Rating PSIG (Bar)	Dawsons-Tech Part No.
T	Min. Opening D	E	I	L			
1/4	13.5	4.8	7.1	21.8	9/16	10,300 (700)	TUC-4TSW
3/8	17.5	7.1	7.9	26.4	11/16	8100 (550)	TUC-6TSW
1/2	20.6	10.4	9.7	28.7	13/16	6600 (450)	TUC-8TSW
3/4	30.5	15.7	11.2	37.9	1-1/8	5900 (400)	TUC-12TSW
1	36.8	22.4	15.7	48.8	1-11/16	5600 (380)	TUC-16TSW

Dimensions are for reference only and are subject to change.

## Male Connector (Tube Socket Weld)

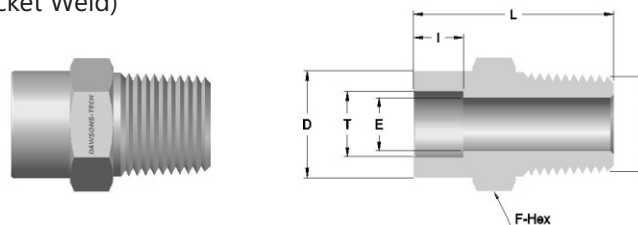

### STANDARD CONFIGURATION DIMENSIONS

Tube OD	Male NPT Thread	Dimensions in mm				F-Hex (Inch)	Pressure Rating PSIG (Bar)	Dawsons-Tech Part No.
T	P	D	Min. Opening E	I	L			
1/4	1/4	12.2	4.8	7.1	29.2	9/16	8000 (545)	MC-4TSW-4N
3/8	1/4	15.6	7.1	7.9	31.8	5/8	8000 (545)	MC-6TSW-4N
3/8	3/8	15.8	7.1	7.9	31.8	11/16	7800 (530)	MC-6TSW-6N
3/8	1/2	15.8	7.1	7.9	37.3	7/8	7800 (530)	MC-6TSW-8N
1/2	1/4	18.5	7.1	9.7	33.3	3/4	6600 (445)	MC-8TSW-4N
1/2	3/4	18.5	9.7	9.7	33.3	3/4	6600 (445)	MC-8TSW-6N
1/2	1/2	18.5	10.4	9.7	38.9	7/8	6600 (445)	MC-8TSW-8N

Dimensions are for reference only and are subject to change.

## Male Elbow (Tube Socket Weld)

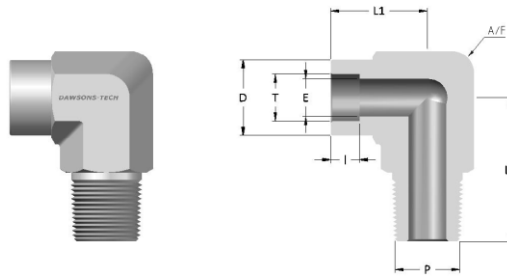

### STANDARD CONFIGURATION DIMENSIONS

Tube OD	Male NPT Thread	Dimensions in mm					A/F (Inch)	Pressure Rating PSIG (Bar)	Dawsons-Tech Part No.
T	P	D	Min. Opening E	I	L1	L2			
1/4	1/4	13.5	4.8	7.1	20.1	24.0	9/16	8000 (545)	ME-4TSW-4N
3/8	1/4	17.5	7.1	7.9	26.4	26.7	11/16	8000 (545)	ME-6TSW-4N
3/8	3/8	17.5	7.1	7.9	24.6	26.2	11/16	7800 (530)	ME-6TSW-6N
3/8	1/2	17.5	7.1	7.9	25.9	36.9	13/16	7800 (530)	ME-6TSW-8N
1/2	1/2	20.6	10.4	9.7	27.4	36.9	13/16	6600 (445)	ME-8TSW-8N

Dimensions are for reference only and are subject to change.

## Female Connector (Tube Socket Weld)

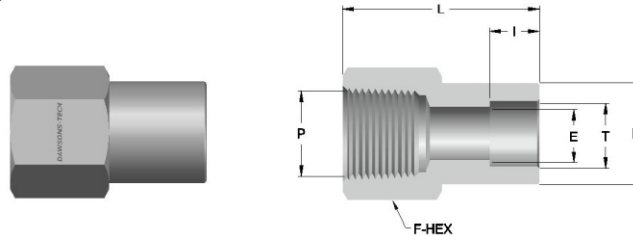

### STANDARD CONFIGURATION DIMENSIONS

Tube OD	Female NPT Thread	Dimensions in mm				F-Hex (Inch)	Pressure Rating PSIG (Bar)	Dawsons-Tech Part No.
T	P	D	Min. Opening E	I	L			
1/8	1/8	7.4	2.3	2.5	21.1	9/16	6500 (440)	FC-2TSW-2N
1/4	1/8	12.2	4.8	7.1	26.7	9/16	6500 (440)	FC-4TSW-2N
1/4	1/4	12.2	4.8	7.1	30.0	3/4	6600 (450)	FC-4TSW-4N
3/8	1/4	15.2	7.1	7.9	31.5	3/4	6600 (450)	FC-6TSW-4N
1/2	3/8	18.5	10.4	9.7	34.5	7/8	5300 (360)	FC-8TSW-6N
1/2	1/2	18.5	10.4	9.7	40.4	1-1/16	4900 (335)	FC-8TSW-8N
3/4	3/4	26.4	15.7	11.2	43.9	1-5/16	4600 (315)	FC-12TSW-12N

Dimensions are for reference only and are subject to change.

## Female Elbow (Tube Socket Weld)

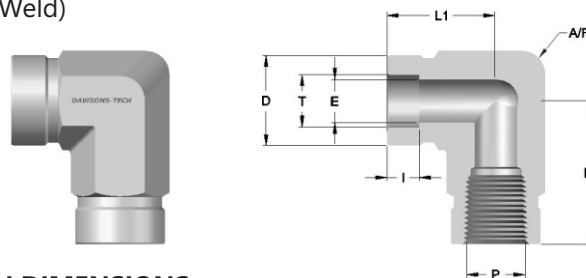

### STANDARD CONFIGURATION DIMENSIONS

Tube OD	Male NPT Thread	Dimensions in mm					A/F (Inch)	Pressure Rating PSIG (Bar)	Dawsons-Tech Part No.
T	P	D	Min. Opening E	I	L1	L2			
1/4	1/4	13.5	4.8	7.1	22.9	29.7	3/4	6600 (445)	FE-4TSW-4N
3/8	1/4	17.5	7.1	7.9	25.1	29.7	3/4	5300 (360)	FE-6TSW-4N
3/8	1/2	17.5	7.1	7.9	28.7	39.6	1-1/16	4900 (335)	FE-6TSW-8N
1/2	1/2	20.6	10.4	9.7	30.2	39.6	1-1/16	4900 (335)	FE-8TSW-8N

Dimensions are for reference only and are subject to change.



## Reducing Adapter (Pipe Butt Weld to Tube Socket Weld)

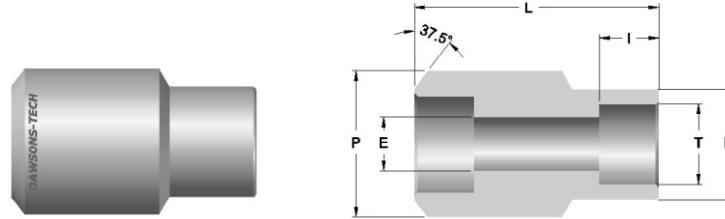

### STANDARD CONFIGURATION DIMENSIONS

Pipe Size	Tube OD	Dimensions in mm				Pressure Rating PSIG (Bar)	Dawsons-Tech Part No.
P	T	D	Min. Opening E	I	L		
1/4	1/4	12.2	4.8	7.1	22.4	10,300 (700)	RA-4PBW-4TSW
3/8	3/8	15.2	7.1	7.9	26.2	8100 (550)	RA-6PBW-6TSW
3/8	1/2	18.5	10.4	7.9	25.4	6600 (450)	RA-6PBW-8TSW
1/2	1/4	12.2	4.8	7.1	28.4	7800 (530)	RA-8PBW-4TSW
1/2	3/8	15.2	7.1	7.9	28.4	7800 (530)	RA-8PBW-6TSW
1/2	1/2	18.5	10.4	9.7	30.2	6600 (450)	RA-8PBW-8TSW
3/4	3/8	15.2	7.1	7.9	38.1	6600 (450)	RA-124PBW-6TSW
3/4	1/2	18.5	10.4	9.7	38.1	6600 (450)	RA-12PBW-8TSW
3/4	3/4	26.7	15.7	11.2	38.1	5900 (400)	RA-12PBW-12TSW
1	3/8	15.2	7.1	7.9	35.1	6000 (410)	RA-16PBW-6TSW
1	1/2	18.5	10.4	9.7	39.6	6000 (410)	RA-16PBW-8TSW

Dimensions are for reference only and are subject to change.

## Union (Pipe Socket Weld)

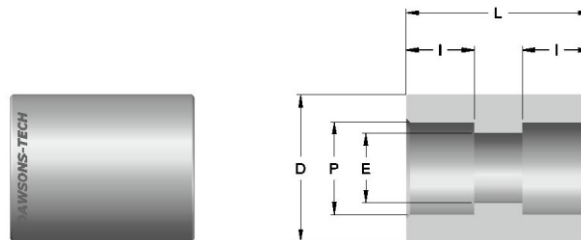

### STANDARD CONFIGURATION DIMENSIONS

Pipe Size	Dimensions in mm				Pressure Rating PSIG (Bar)	Dawsons-Tech Part No.
P	D	Min. Opening E	I	L		
1/4	22.4	9.1	9.9	26.9	8100 (550)	U-4PSW
3/8	26.2	12.4	9.9	28.4	7100 (480)	U-6PSW
1/2	31.8	15.7	9.9	28.4	6800 (460)	U-8PSW
3/4	37.3	20.8	13.0	44.5	5800 (400)	U-12PSW
1	47.2	26.7	13.0	44.5	6100 (410)	U-16PSW

Dimensions are for reference only and are subject to change.

## MALE ADAPTER (Male NPT Threads to Tube End)

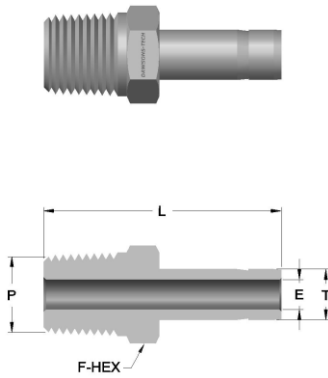

Tube OD T	NPT Thread Size P	Dimensions in mm		F-Hex (Inch)	Dawsons-Tech Part No.
		E	L		
<b>Fractional</b>					
1/8	1/8	2.0	29.5	7/16	MA-2-2N
1/8	1/4	2.0	34.8	9/16	MA-2-4N
3/16	1/8	3.0	30.2	7/16	MA-3-2N
3/16	1/4	3.0	35.5	9/16	MA-3-4N
1/4	1/8	4.1	32.8	7/16	MA-4-2N
1/4	1/4	4.1	38.1	9/16	MA-4-4N
1/4	3/8	4.3	37.8	11/16	MA-4-6N
1/4	1/2	4.3	43.4	7/8	MA-4-8N
5/16	1/8	4.8	32.7	7/16	MA-5-2N
5/16	1/4	5.6	39.1	9/16	MA-5-4N
3/8	1/8	4.8	33.5	7/16	MA-6-2N
3/8	1/4	6.9	39.9	9/16	MA-6-4N
3/8	3/8	6.9	40.6	11/16	MA-6-6N
3/8	1/2	6.9	45.2	7/8	MA-6-8N
1/2	1/4	7.1	46.5	9/16	MA-8-4N
1/2	3/8	9.4	45.2	11/16	MA-8-6N
1/2	1/2	9.4	52.1	7/8	MA-8-8N
5/8	1/2	11.9	52.3	7/8	MA-10-8N
3/4	1/2	11.9	52.3	7/8	MA-12-8N
3/4	3/4	14.7	52.3	1-1/16	MA-12-12N
1	3/4	15.7	58.6	1-1/16	MA-16-12N
1	1	20.3	66.0	1-3/8	MA-16-16N
<b>Metric</b>					
6mm	1/8	4.1	32.8	7/16	MA-6M-2N
6mm	1/4	4.1	38.1	9/16	MA-6M-4N
8mm	1/4	5.6	39.1	9/16	MA-8M-4N
10mm	1/4	6.9	39.9	9/16	MA-10M-4N
10mm	3/8	6.9	40.6	11/16	MA-10M-6N
10mm	1/8	6.9	45.2	7/8	MA-10M-8N
12mm	1/4	7.1	46.5	9/16	MA-12M-4N
12mm	1/2	9.4	52.1	7/8	MA-12M-8N

Dimensions are for reference only and are subject to change.

## MALE ADAPTER (Male ISO Tapered (BSPT) Threads to Tube End)

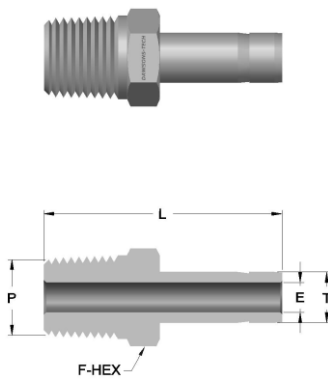

Tube OD T	BSPT Thread Size P	Dimensions in mm		F-Hex (Inch)	Dawsons-Tech Part No.
		E	L		
<b>Fractional</b>					
1/8	1/8	2.0	29.5	7/16	MA-2-2RT
1/8	1/4	2.0	34.8	9/16	MA-2-4RT
1/4	1/8	4.1	32.8	7/16	MA-4-2RT
1/4	1/4	4.1	38.1	9/16	MA-4-4RT
3/8	1/4	6.9	39.9	9/16	MA-6-4RT
3/8	3/8	6.9	40.6	11/16	MA-6-6RT
3/8	1/2	6.9	45.2	7/8	MA-6-8RT
1/2	1/4	7.1	46.5	9/16	MA-8-4RT
1/2	3/8	9.4	45.2	11/16	MA-8-6RT
1/2	1/2	9.4	50.8	7/8	MA-8-8RT
3/4	3/4	14.7	52.3	1-1/16	MA-12-12RT
1	1	20.3	66.0	1-3/8	MA-16-16RT
<b>Metric</b>					
6mm	1/8	4.1	32.8	7/16	MA-6M-2RT
6mm	1/4	4.1	38.1	9/16	MA-6M-4RT
8mm	1/4	5.6	39.1	9/16	MA-8M-4RT
10mm	1/4	6.9	39.9	9/16	MA-10M-4RT
10mm	3/8	6.9	40.6	11/16	MA-10M-6RT
12mm	1/4	7.1	46.5	9/16	MA-12M-4RT
12mm	3/8	9.4	45.2	11/16	MA-12M-6RT
12mm	1/2	9.4	50.8	7/8	MA-12M-8RT

Dimensions are for reference only and are subject to change.

## MALE ADAPTER (Male ISO Parallel (BSP) (According to DIN 3852 Part 2 Form B) to Tube End)

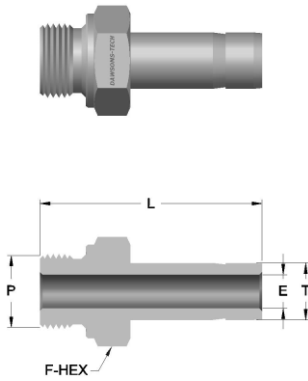

Tube OD T	BSP Thread Size P	Dimensions in mm		F-Hex (Inch)	Dawsons-Tech Part No.
		E	L		
<b>Fractional</b>					
1/8	1/8	2.0	31.0	9/16	MA-2-2RP
1/8	1/4	2.0	35.8	3/4	MA-2-4RP
1/4	1/8	4.0	34.3	9/16	MA-4-2RP
1/4	1/4	4.1	38.1	3/4	MA-4-4RP
3/8	1/4	5.9	39.8	3/4	MA-6-4RP
3/8	3/8	6.9	40.6	7/8	MA-6-6RP
1/2	1/4	5.9	45.4	3/4	MA-8-4RP
1/2	3/8	7.9	46.2	7/8	MA-8-6RP
1/2	1/2	8.8	49.2	1-1/16	MA-8-8RP
3/4	3/4	13.9	54.8	1-1/4	MA-12-12RP
1	1	20.3	64.5	1-5/8	MA-16-16RP
<b>Metric</b>					
6mm	1/8	4.0	34.3	9/16	MA-6M-2RP
6mm	1/4	4.1	38.1	3/4	MA-6M-4RP
8mm	1/4	5.6	39.8	3/4	MA-8M-4RP
10mm	1/4	5.9	39.8	3/4	MA-10M-4RP
10mm	3/8	6.9	40.6	7/8	MA-10M-6RP
10mm	1/2	7.1	44.7	1-1/16	MA-10M-8RP
12mm	1/4	5.9	45.4	3/4	MA-12M-4RP
12mm	3/8	7.9	46.2	7/8	MA-12M-6RP
12mm	1/2	8.8	49.2	1-1/16	MA-12M-8RP
18mm	1/2	11.9	52.1	1-1/16	MA-18M-8RP
18mm	3/4	13.9	54.8	1-1/4	MA-18M-12RP

Dimensions are for reference only and are subject to change.

## MALE ADAPTER (Male ISO Parallel (BSP) (According to DIN 3852 Part 2 Form E) to Tube End)

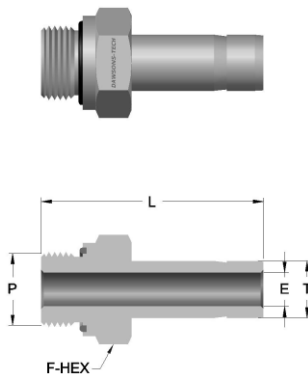

Tube OD T	BSP Thread Size P	Dimensions in mm		F-Hex (Inch)	Dawsons-Tech Part No.
		E	L		
<b>Fractional</b>					
1/8	1/8	2.0	31.0	9/16	MA-2-2EO
1/8	1/4	2.0	35.8	3/4	MA-2-4EO
1/4	1/8	4.0	34.3	9/16	MA-4-2EO
1/4	1/4	4.1	38.1	3/4	MA-4-4EO
3/8	1/4	5.9	39.8	3/4	MA-6-4EO
3/8	3/8	6.9	40.6	7/8	MA-6-6EO
1/2	1/4	5.9	45.4	3/4	MA-8-4EO
1/2	3/8	7.9	46.2	7/8	MA-8-6EO
1/2	1/2	8.8	49.2	1-1/16	MA-8-8EO
3/4	3/4	13.9	54.8	1-1/4	MA-12-12EO
1	1	20.3	64.5	1-5/8	MA-16-16EO
<b>Metric</b>					
6mm	1/8	4.0	34.3	9/16	MA-6M-2EO
6mm	1/4	4.1	38.1	3/4	MA-6M-4EO
8mm	1/4	5.6	39.8	3/4	MA-8M-4EO
10mm	1/4	5.9	39.8	3/4	MA-10M-4EO
10mm	3/8	6.9	40.6	7/8	MA-10M-6EO
10mm	1/2	7.1	44.7	1-1/16	MA-10M-8EO
12mm	1/4	5.9	45.4	3/4	MA-12M-4EO
12mm	3/8	7.9	46.2	7/8	MA-12M-6EO
12mm	1/2	8.8	49.2	1-1/16	MA-12M-8EO
18mm	1/2	11.9	52.1	1-1/16	MA-18M-8EO
18mm	3/4	13.9	54.8	1-1/4	MA-18M-12EO

Dimensions are for reference only and are subject to change.

## FEMALE ADAPTER (Female NPT Threads to Tube End)

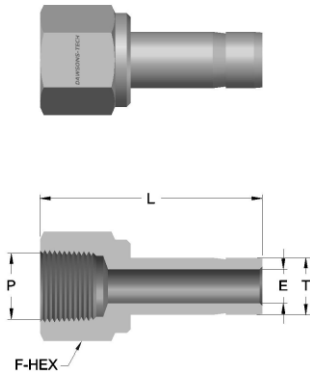

Tube OD T	NPT Thread Size P	Dimensions in mm		F-Hex (Inch)	Dawsons-Tech Part No.
		E	L		
<b>Fractional</b>					
1/8	1/8	2.0	31.5	9/16	FA-2-2N
1/8	1/4	2.0	35.3	3/4	FA-2-4N
3/16	1/4	3.0	35.8	3/4	FA-3-2N
1/4	1/8	4.1	33.0	9/16	FA-4-2N
1/4	1/4	4.1	37.1	3/4	FA-4-4N
1/4	3/8	4.1	39.4	7/8	FA-4-6N
1/4	1/2	4.1	45.5	1-1/16	FA-4-8N
5/16	1/4	5.6	37.6	3/4	FA-5-8N
3/8	1/8	6.9	34.6	9/16	FA-6-2N
3/8	1/4	6.9	38.1	3/4	FA-6-4N
3/8	3/8	6.9	40.4	7/8	FA-6-6N
3/8	1/2	6.9	46.7	1-1/16	FA-6-8N
1/2	1/4	8.8	43.7	3/4	FA-8-4N
1/2	3/8	9.4	45.5	7/8	FA-8-6N
1/2	1/2	8.8	52.3	1-1/16	FA-8-8N
5/8	1/2	11.9	53.1	1-1/16	FA-10-8N
3/4	1/2	14.7	52.8	1-1/16	FA-12-8N
3/4	3/4	14.7	54.9	1-1/4	FA-12-12N
3/4	1	14.7	58.4	1-5/8	FA-16-12N
1	3/4	20.3	60.7	1-1/4	FA-16-12N
1	1	20.3	64.2	1-5/8	FA-16-16N
<b>Metric</b>					
6mm	1/8	4.1	33.0	9/16	FA-6M-2N
6mm	1/4	4.1	37.1	3/4	FA-6M-4N
8mm	1/4	5.6	37.6	3/4	FA-8M-4N
10mm	1/4	6.9	38.1	3/4	FA-10M-4N
10mm	3/8	6.9	40.4	7/8	FA-10M-6N
10mm	1/2	6.9	46.7	1-1/16	FA-10M-8N
12mm	1/4	8.8	43.7	3/4	FA-12M-8N
12mm	1/2	8.8	52.3	1-1/16	FA-12M-8N

Dimensions are for reference only and are subject to change.

## FEMALE ADAPTER (Female ISO Tapered (BSPT) Threads to Tube End)

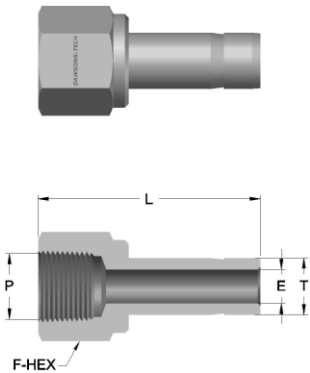

Tube OD T	BSPT Thread Size P	Dimensions in mm		F-Hex (Inch)	Dawsons-Tech Part No.
		E	L		
<b>Fractional</b>					
1/4	1/8	4.1	33.0	9/16	FA-4-2RT
1/4	1/4	4.1	37.1	3/4	FA-4-4RT
3/8	1/4	6.9	38.1	3/4	FA-6-4RT
3/8	3/8	6.9	40.4	7/8	FA-6-6RT
1/2	1/4	8.8	43.7	3/4	FA-8-4RT
1/2	3/8	9.4	45.5	7/8	FA-8-6RT
1/2	1/2	8.8	52.3	1-1/16	FA-8-8RT
<b>Metric</b>					
6mm	1/8	4.1	33.0	9/16	FA-6M-2RT
10mm	1/4	6.9	38.1	3/4	FA-10M-4RT

Dimensions are for reference only and are subject to change.

## FEMALE ADAPTER (Female ISO Parallel Threads (BSP) to Tube End)

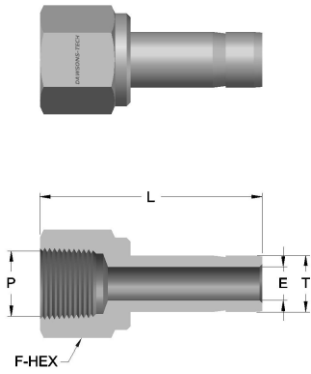

Tube OD T	BSP Thread Size P	Dimensions in mm		F-Hex (Inch)	Dawsons-Tech Part No.
		E	L		
<b>Fractional</b>					
1/4	1/4	4.1	35.3	3/4	FA-4-2RG
3/8	3/8	6.6	39.4	7/8	FA-6-6RG
1/2	1/2	7.1	48.8	1-1/16	FA-8-8RG
<b>Metric</b>					
6mm	1/4	4.1	35.3	3/4	FA-6M-4RG
6mm	3/8	4.1	38.4	7/8	FA-6M-6RG
6mm	1/2	4.1	42.9	1-1/16	FA-6M-8RG
8mm	1/4	5.5	33.0	3/4	FA-8M-4RG
8mm	1/2	5.6	43.7	1-1/16	FA-8M-8RG
10mm	1/4	5.5	34.5	3/4	FA-10M-4RG
10mm	1/2	7.1	41.1	1-1/16	FA-10M-8RG
12mm	1/4	5.5	40.1	3/4	FA-12M-4RG
12mm	1/2	7.1	48.8	1-1/16	FA-12M-8RG
16mm	1/2	7.1	49.0	1-1/16	FA-16M-8RG
18mm	1/2	7.1	49.3	1-1/16	FA-18M-8RG

Dimensions are for reference only and are subject to change.

## MALE HOSE ADAPTER (Barb End to Male NPT End)

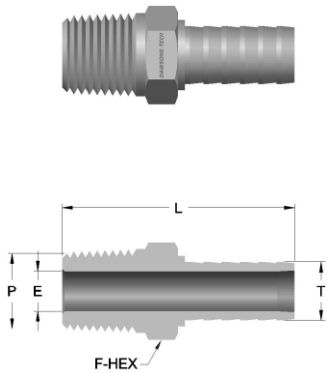

Tube OD T	NPT Thread Size P	Dimensions in mm		F-Hex (Inch)	Dawsons-Tech Part No.
		E	L		
1/8	1/8	2.0	27.4	7/16	MHA-2-2N
1/8	1/4	2.0	32.0	9/16	MHA-2-4N
3/16	1/8	3.0	32.3	7/16	MHA-3-2N
3/16	1/4	3.0	36.8	9/16	MHA-3-4N
1/4	1/8	4.8	37.3	7/16	MHA-4-2N
1/4	1/4	4.8	41.9	9/16	MHA-4-4N
1/4	3/8	4.8	42.2	11/16	MHA-4-6N
1/4	1/2	4.8	47.0	7/8	MHA-4-8N
5/16	1/8	4.8	39.4	7/16	MHA-5-2N
5/16	1/4	4.8	43.9	9/16	MHA-5-4N
5/16	1/8	4.8	44.2	7/16	MHA-5-6N
5/16	1/2	4.8	49.8	7/8	MHA-5-8N
3/8	1/4	7.6	43.9	9/16	MHA-6-4N
3/8	3/8	7.6	44.2	11/16	MHA-6-6N
3/8	1/2	7.6	49.8	7/8	MHA-6-8N
1/2	1/4	9.5	45.7	9/16	MHA-8-4N
1/2	3/8	9.5	46.0	11/16	MHA-8-6N
1/2	1/2	9.5	51.6	7/8	MHA-8-8N
5/8	1/2	11.9	52.6	7/8	MHA-10-8N
5/8	3/4	12.7	52.6	1-1/16	MHA-10-12N
3/4	1/2	16.0	54.4	7/8	MHA-12-8N
3/4	3/4	16.0	54.4	1-1/16	MHA-12-12N
3/4	1	16.2	61.7	1-3/8	MHA-12-16N
1	3/4	22.4	60.5	1-1/16	MHA-16-12N
1	1	22.4	65.3	1-3/8	MHA-16-16N

Dimensions are for reference only and are subject to change.

## AN Male ADAPTER (AN Male Thread to The End)

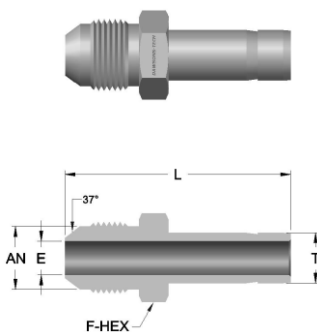

Tube OD T	AN Tube Flare Size	Thread Size	Dimensions in mm		F-Hex (Inch)	Dawsons-Tech Part No.
			E	L		
1/4	1/4	7/16 x 20	4.3	37.1	1/2	NMA-4-4AN
3/8	1/4	7/16 x 20	4.3	38.9	1/2	NMA-6-4AN
3/8	3/8	9/16 x 18	6.9	39.6	5/8	NMA-6-6AN
1/2	1/2	3/4 x 16	9.4	48.5	13/16	NMA-8-8AN
3/4	3/4	1-1/16 x 12	14.7	56.1	1-1/8	NMA-12-12AN
1	1	1-5/16 x 12	20.3	65.5	1-3/8	NMA-16-16AN

Dimensions are for reference only and are subject to change.

## TUBE to HOSE ADAPTER (Barb End to Tube End)

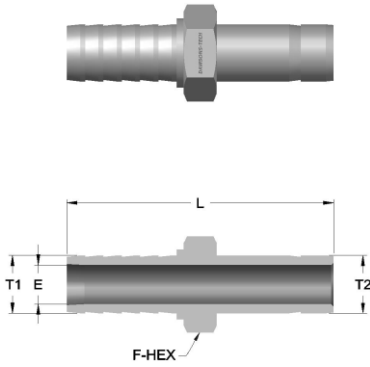

Hose ID	Tube OD Size	Dimensions in mm		F-Hex (Inch)	Dawsons-Tech Part No.
		E	L		
1/8	1/8	2.0	34.3	5/16	THA-2-2
1/8	1/4	2.0	36.6	3/8	THA-2-4
1/4	1/4	4.8	46.5	7/16	THA-4-4
1/4	3/8	4.8	48.3	7/16	THA-4-6
5/16	1/4	4.8	48.5	7/16	THA-5-4
3/8	3/8	7.6	50.3	9/16	THA-6-6
3/8	1/2	7.6	55.9	5/8	THA-6-8
1/2	3/8	9.7	52.1	11/16	THA-8-6
1/2	1/2	9.7	57.7	11/16	THA-8-8
3/4	3/4	16.0	62.0	7/8	THA-12-12

Dimensions are for reference only and are subject to change.

## ORDERING INFORMATION

### PRECISION THREADED PIPE FITTINGS

For Example : PART NO. : HN-8N-8RT-SS

Type of Fittings	End Connection Pipe Thread Size & Type 1	End Connection Pipe Thread Size & Type 2	Material of Construction
HN	8N	8RT	SS
Hex Nipple	1/2" NPT	1/2" BSPT	SS316

### SOCKET / BUTT WELD PIPE FITTINGS

For Example : PART NO. : MC-8TSW-8N-SS

Type of Fittings	Tube OD	End Connection Pipe Thread Size & Type	Material of Construction
MC	8TSW	8N	SS
Male Connector	1/2" Tube Socket Weld	1/2" NPT	SS316

### TUBE ADAPTERS

For Example : PART NO. : MA-8-8N-SS

Type of Adapters	Tube OD	End Connection Pipe Thread Size & Type	Material of Construction
AM	8	8N	SS
Male Adapter	1/2"	1/2" NPT	SS316

### Part No. Code Description :

End Connection Pipe Thread Size	2	1/8"
	4	1/4"
6	3/8"	
7	7/16"	
8	1/2"	
9	9/16"	
10	5/8"	
12	3/4"	
14	7/8"	
16	1"	

End Connection Thread Type	<b>N</b>	: NPT
	<b>RT</b>	: BSPT
	<b>RP</b>	: BSP (Male)
	<b>RG</b>	: BSP (Female)
	<b>SAE</b>	: Straight Thread
	<b>ED</b>	: BSP (Male) (With Elastic Sealing)
	<b>TSW</b>	: Tube Socket Weld
	<b>TBW</b>	: Tube Butt Weld
	<b>PSW</b>	: Pipe Socket Weld
	<b>PBW</b>	: Pipe Butt Weld

Tube OD Size			
Fractional		Metric	
2	1/8"	6M	6mm
3	3/16"	8M	8mm
4	1/4"	10M	10mm
5	5/16"	12M	12mm
6	3/8"	16M	16mm
8	1/2"	18M	18mm
10	5/8"		
12	3/4"		
16	1"		

Material of Construction	<b>SS</b>	: SS316
	<b>SSL</b>	: SS316L
	<b>Duplex</b>	: D
	<b>Monel</b>	: M
	<b>Inconel 625</b>	: I6
	<b>Inconel 825</b>	: I8



Fueling Products



Twin Ferrule Compression Tube Fittings



Tube Fittings for Pressure Rating 15000 PSIG



37° FLARE FITTINGS



Quick Connect Coupling



2 Way Ball Valves



3 Way Trunnion Ball Valves



Check Valves

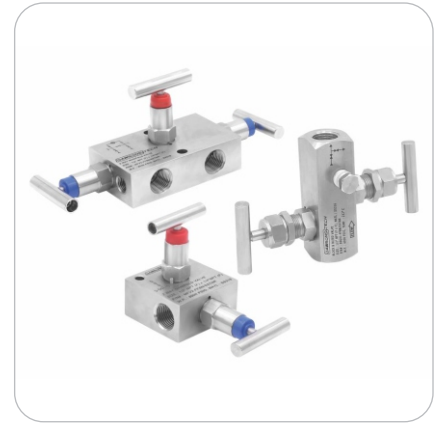

2 / 3 Way Manifold / Block & Bleed Valves



Relief Valves



CNG Receptacles  
Series : DTLR01 & DTLR03





CNG Receptacles  
Series : DTSR05 & DTSR07



Registered Office and Manufacturing Plant :

## **DAWSONS-TECH COMPONENTS LLP**

 Unit No. DD - 6 & 7, Khan Real Industrial Estate,  
N. H. 08, Pelhar, Vasai Phata, Vasai (East),  
Dist. Palghar - 401 208, Maharashtra, India.  
LLPIN: AAN-0434

 Mobile : +91-9833355596

 Email : [info@dawsonstech.com](mailto:info@dawsonstech.com)

 Website: [www.dawsonstech.com](http://www.dawsonstech.com)